



# FuelTech



**FT350**  
**FT400**

Programmable Electronic Fuel Injection and Ignition System

**Installation and Operation Guide**



1. Index	
2. Presentation.....	5
3. Warranty terms .....	6
4. Characteristics.....	7
5. Installation.....	8
5.1 Main harness connections.....	8
5.2 Auxiliary harness connections (FT400 only).....	9
5.3 Main switch installation (optional) – important tips .....	11
5.4 Built-in MAP sensor .....	11
5.5 USB/CAN converter.....	11
6. Sensors.....	12
6.1 Intake air temperature sensor .....	12
6.2 Engine temperature sensor.....	12
6.3 Fuel and oil pressure sensor – PS-10B sensor.....	12
6.4 Throttle position sensor (TPS).....	12
6.5 Crankshaft position sensor (CKP).....	12
6.6 Camshaft position sensor .....	15
6.7 O2 sensor.....	15
7. Fuel injectors.....	16
7.1 High impedance fuel injectors.....	16
7.2 Low impedance fuel injectors .....	16
8. Ignition.....	17
8.1 Ignition with distributor.....	17
8.2 Ignition with crankshaft trigger wheel.....	17
9. Auxiliary outputs.....	20
9.1 Thermatic fan.....	20
9.2 Air conditioning (FT400 only).....	20
9.3 Shift alert.....	21
9.4 Fuel pump .....	21
9.5 Variable camshaft control/Powerglide gears.....	21
9.6 Progressive nitrous control.....	21
9.7 Boost control.....	21
10. Electronic throttle control – ETC (FT400 only).....	22
10.1 Wiring table – pedals and throttle bodies .....	23
11. Using the module .....	26
11.1 Shortcuts and menu navigation.....	26
11.2 Dashboard screen .....	27
11.3 Diagnostic panel.....	27
12. Configuration and settings – step by step.....	28
12.1 First step – fuel injection setup .....	28
12.2 Second step – ignition setup .....	30
12.3 Third step – generate FuelTech defaults.....	32
12.4 Fourth step – sensors check-up and throttle position sensor (TPS) calibration .....	33
13. Starting the engine for the first time.....	34
13.1 Ignition calibration.....	34
14. Fuel injection tables adjust.....	35
14.1 Main fuel table (load) .....	35
14.2 Overall fuel trim .....	37
14.3 RPM compensation table .....	37
14.4 Acceleration fuel enrichment.....	37
14.5 Tuning aid (FT400 only).....	38
14.6 Closed loop (FT400 only).....	40
14.7 Safety tips during Tuning aid and closed loop (FT400 only) .....	41
14.8 Engine temperature fuel compensation.....	41
14.9 Air temperature fuel compensation .....	42
14.10 Battery voltage fuel compensation .....	42
15. Ignition tables adjust.....	42
15.1 Main ignition table (RPM) .....	42
15.2 Overall ignition trim.....	42
15.3 MAP/TPS ignition compensation .....	42
15.4 Engine temperature compensation .....	43
15.5 Air temperature compensation.....	43
15.6 Timing split .....	43
16. Auxiliary functions adjust.....	43
16.1 Internal datalogger .....	43
16.2 Engine start .....	44
16.3 Revolution limiter .....	44
16.4 Deceleration cut-off .....	45
16.5 Anti-lag – turbo spooling.....	45
16.6 Two-step rev limiter.....	45
16.7 Time based RPM control .....	46
16.8 Burnout mode.....	46
16.9 Thermatic fan .....	46
16.10 Idle speed control.....	46
16.11 Shift alert.....	49
16.12 Fuel pump .....	49
16.13 Variable camshaft control .....	49
16.14 Progressive nitrous control.....	49
16.15 Boost control .....	50
17. Input and output setup .....	50
17.1 Electronic Throttle Control – ETC (FT400 only) .....	50
18. Alert settings.....	51
19. Interface settings .....	52
19.1 Brightness settings.....	52
19.2 Sound settings.....	52

19.3 Protection setup.....	52
19.4 Clear peaks.....	53
19.5 Dashboard setup .....	53
19.6 Startup screen.....	53
19.7 Recalibrate touchscreen.....	53
19.8 Serial number and software version.....	53
20. Files manager – memory positions and functions .....	53
21. Rotary engines setup.....	54
21.1 Crank angle sensor installation and alignment.....	54
21.2 Crank angle sensor wiring .....	54
21.3 ECU setup.....	55
21.4 Ignition coils wiring .....	55
21.5 Calibration of the crank angle sensor ignition timing..	56
22. Full wiring diagram.....	57

## 2. Presentation

FT350 and FT400 are real time programmable ECUs that allow creation and edition of all fuel and timing maps according to the engine. The programming can be done directly on the module, either through its exclusive 4.3" touch screen, which displays all maps and corrections in 2D and gives access to all functions and configurations, or through the computer software with communication connection via CAN-USB adapter, which allows access to 2D and 3D maps that facilitate visualization and engine tuning. It can be applied to any type of Otto cycle engines (street/road cars, racing cars, 2T or 4T engine motorcycle, aquatic crafts with automotive engines, stationary engines, among others).



Electronic throttle control is totally integrated to FT400 and everything can be setup directly through its screen with no need to use additional modules. FT350 does not have this control, thus, need an external driver (like FuelTech ETC) to control electronic throttles. It is possible to program configurable alerts for situations that can be harmful to the engine, such as: RPM excess, oil and fuel pressure, air and engine temperature, among others. These alerts can be programmed to cut-off the engine for greater safety. The injection system also has 5 totally independent maps, which allow 5 different configurations for engines and/or cars.



Ignition control can be done with the use of a Hall Effect distributor, a crankshaft trigger wheel distributor or both, thus allowing the use of individual or double ignition coils, as well as individually designated ignition coils per cylinder.

In order to make it easier to build engines with a large number of cylinders, the FT-400 make it possible to drive up to 12 high impedance fuel injectors.

The computer software shows all parameters configured and read by real-time fuel injection, and also backs-up its maps and configurations.

### 3. Warranty terms

The use of this equipment implies the total accordance with the terms described in this manual and exempts the manufacturer from any responsibility regarding to product misuse.

Read all the information in this manual before starting the product installation.



**NOTE:**

*This product must be installed and tuned by specialized auto shops and/or personnel with experience on engine preparation and tuning.*

Before starting any electric installation, disconnect the battery.

The inobservance of any of the warnings or precautions described in this manual might cause engine damage and lead to the invalidation of this product warranty. The improper adjustment of the product might cause engine damage.

This product does not have a certification for the use on aircrafts or any flying devices, as it has not been designed for such use purpose.

In some countries where an annual inspection of vehicles is enforced, no modification in the original fuel injection system is permitted. Be informed about local laws and regulations prior to the product installation.

#### Important warnings for the proper installation of this product:

- Always cut the unused parts of cables off – NEVER roll up the excess as it becomes an interference capturing antenna and it can result on equipment malfunction.
- The black wire in the cable MUST be connected directly to the battery's negative terminal, as well as each one of the sensors' ground wires.
- The black/white wire MUST be connected directly to the engine block or head. By doing so, many interference problems are avoided.

#### Limited warranty

All products manufactured by FUELTECH are warranted to be free from defects in material and workmanship for one year following the date of original purchase. Warranty claim must be made by original owner with proof of purchase from authorized reseller. This warranty does not include sensors or other products that FUELTECH carries but did not manufacture. If a product is found defective, such products will, at FUELTECH's option, be replaced or repaired at cost to FUELTECH. All products alleged by Purchaser to be defective must be returned to FUELTECH, postage prepaid, within one year warranty period.

This limited warranty does not cover labor or other costs or expenses incidental to the repair and/or replacement of products or parts. This limited warranty does not apply to any product which has been subject to misuse, mishandling, misapplication, neglect (including but not limited to improper maintenance), accident, improper installation, tampered seal, modification (including but not limited to use of unauthorized parts or attachments), or adjustment or repair performed by anyone other than FUELTECH.

The parties hereto expressly agree that the purchaser's sole and exclusive remedy against FUELTECH shall be for the repair or replacement of the defective product as provided in this limited warranty. This exclusive remedy shall not be deemed to have failed of its essential purpose so long as FUELTECH is willing and able to repair or replace defective goods.

FUELTECH reserves the right to request additional information such as, but not limited to, tune up and log files in order to evaluate a claim.

Seal violation voids warranty and renders loss of access to upgrade releases.

Manual version 1.7 – August/2017

ECU main version: 2.01



## 4. Characteristics

### Specifications and inputs

- Maximum RPM: 16000rpm;
- Built in MAP Sensor - 7bar (100psi), being 1bar related to the vacuum and 6bar related to the positive pressure;
- 4.3" touch screen with 16.8 million colors;
- 1, 2, 3, 4, 5, 6, 8, 10 and 12-cylinder engines;
- Throttle Position Sensor (TPS) can be calibrated to any linear sensor;
- Input for electronic pedal and electronic throttle with double position sensor (FT400 only);
- Coolant and Intake Air Temperature Input, Oil and Fuel Pressure Input;
- 7 auxiliary outputs (FT400 only). FT350 has only 4 auxiliary outputs;
- 4 configurable inputs (engine coolant and intake air; temperature, fuel and oil pressure and O2 sensor) (FT350 only);
- Ignition Control by crankshaft trigger wheel or distributor;
- Control up to 12 injectors in 2 independent banks. More injectors can be controlled with a Peak and Hold Module;
- Working temperature range: -10°C to 60°C;

### Functions

- Automatically mapping of fuel injection maps (FT400 only);
- Lambda control by closed loop (FT400 only);
- Electronic throttle control (FT400 only);
- Main map options: Aspirated by TPS, Aspirated by TPS/MAP, Aspirated by MAP, Turbo by MAP;
- Idle speed control adjustment options: by MAP or by TPS;
- Programmable in real-time on the equipment or with the PC software;
- Fuel injection and ignition map based on RPM;
- Main fuel injection map overall trim function;
- Correction of ignition timing based on turbo vacuum and pressure or throttle position sensor (TPS);
- Fuel injection and ignition compensations based on engine and air temp. (11 temperature points);
- Correction of fuel injection based on battery voltage (with 1.0V interval);
- Revolution limiter based on fuel cut-off, ignition cut-off, or ignition cut-off and closing of the electronic throttle;
- Deceleration fuel cut-off;
- Launch cut with timing delay and enrichment (Two-Step);
- Burnout Mode;
- Electronic control of the electric fan based on engine temperature;
- Idle air valve control based on engine temperature, minimum RPM and after-launch;
- Adjustable engine starting injection based on engine temperature (3 parameters);
- Electric fuel pump control based on time;
- Actuation of the Variable Valve Timing Control System (VTEC);
- Progressive nitrous control with mixture enrichment and timing delay;

- Boost pressure control based on RPM with mixture enrichment;
- Oil and fuel pressure sensors;
- User and tuner protection passwords;
- Fuel injector dead time adjustment for injectors' real opening calculation;
- Visual and sound shift alert and output for external shift light actuation;
- Check control with warning and engine cut-off based on exceeded pressure, exceeded RPM, engine temperature, saturated injectors, oil pressure, fuel pressure and fuel differential pressure;
- LCD Display backlight adjustment;
- 5 memories to save different adjustment from map banks;

### On-Board computer – dashboard screen

- Fuel injectors' current and maximum injection time (in milliseconds, ms) from each bank;
- Ignition timing (BTDC), injection time (in ms), RPM (in rpm) and TPS (in %);
- MAP pressure: current and maximum value reached (in psi);
- RPM: current and maximum value reached (in rpm);
- Coolant and Intake Air Temperature: current, lowest and highest temperatures reached (in °F);
- Oil and Fuel Pressure: current, lowest and highest (in psi);
- Percentage of boost and nitro used, ignition timing and boost pressure;
- Battery Voltage (in Volts);

### Dimensions:

- 140mm x 80mm x 30mm

## 5. Installation

For FT installation, the electric cable must be disconnected from the module and the vehicle's battery. It is very important that the cable length is the shortest possible and that exceeding unused parts of wires are cut off. Never roll up the excess of any wire in the cable; by doing so, interference problems, which are very usual with any electronic device, are avoided.

Choose an appropriate location to affix the module inside the car, and avoid passing the cable wires close to the ignition wires and cables, ignition coils and other sources of electric noise. Avoid placing the injection module at the engine compartment or where it may be exposed to liquids and heat. DON'T EVER, under any circumstance, install the injection module near the ignition module in order to avoid the risk of interferences.

The black wire in the cable is the signal ground wire, and must be

connected to the battery's negative terminal. The black/white wire is the power ground wire, and must be connected to the vehicle's chassis, apart from the signal ground.

The electric cable must be protected from contact with sharp parts on the vehicle's body that might damage the wires and cause short circuit. Be particularly attentive to wires passing through holes, and use rubber protectors or any other kind of protective material to prevent any damage to the wires. At the engine compartment, pass the wires through places where they will not be subject to excessive heat and will not obstruct any mobile parts in the engine.

Always, when possible, use plastic insulation on cables.



### **IMPORTANT:**

**Fuel only: When using this option, the RPM signal input cannot be connected to a coil high voltage signal because the input has no protection and will damage the trigger input on the ecu. Please use a tach output, another rpm source or an ignition coil to tach adapter module to avoid damage to the unit.**

### 5.1 Main harness connections

Wire Color	Pin	Connection	Note
Green	1	Tachometer output	RPM signal output for tachometers and auxiliary modules.
Yellow – 3	2	Auxiliary output 3	Must be configured prior to the installation.
White/Blue	3	Input 1 – intake air temperature Sensor	The other sensor pin must be connected to the negative.
Yellow – 2	4	Auxiliary output 2	Must be configured prior to the installation.
White	5	Input 2	Must be configured according to the sensor used. FT400: connected to the fuel pressure sensor. FT350: configurable as fuel or oil pressure or O2 sensor input
Yellow – 1	6	Auxiliary output 1	Must be configured prior to the installation.
Pink	7	Input 3 – engine coolant temperature sensor	The other sensor pin must be connected to the negative.
Yellow – 4	8	Auxiliary output 4	Must be configured prior to the installation.
Blue	9	Input 4	Must be configured in accordance with the sensor or function used. FT400: connected to the oil pressure sensor. FT350: configurable as fuel or oil pressure or 2-step input
Gray – E	10	Ignition output E	
Orange	11	Signal from the TPS sensor TPS 1 for electronic throttle	Connect the 3 TPS wires in a way which, when measuring the resistance between the green/red and black wires in the cable, the value does not vary.
Gray – D	12	Ignition output D	
Yellow/Red	13	MAP signal output	Connected to a datalogger, it informs the pressure/vacuum read by the injection inner MAP.
Gray – C	14	Ignition output C	
Green/Yellow	15	Camshaft position sensor input	It reads inductive or Hall effect sensors. It must be configured prior to the installation.
Gray – B	16	Ignition output B	
Shielded Cable	17	RPM signal input	Must be connected to the crankshaft trigger sensor (inductive or Hall) or to the Hall distributor – Discard shield
Gray – A	18	Ignition output A	
Black, Shield	19	Battery's negative terminal	Must be directly connected to the battery; no add-ons or seams allowed. Cannot be connected to vehicle chassis.
Green/Red	20	5V feed for sensors	Feed for TPS, as well as other sensors.
Red	21	Switched 12V supply	Connect directly to ignition switch.
Black/White	22	Chassis ground engine block	Power ground, connected to the vehicle's chassis. Cannot be connected to battery negative terminal.
Brown	23	Negative terminal from fuel injectors – Bank "B"	See chapter 6 in this manual for more information about these outputs and their connections.
Purple	24	Negative terminal from fuel injectors – Bank "A"	



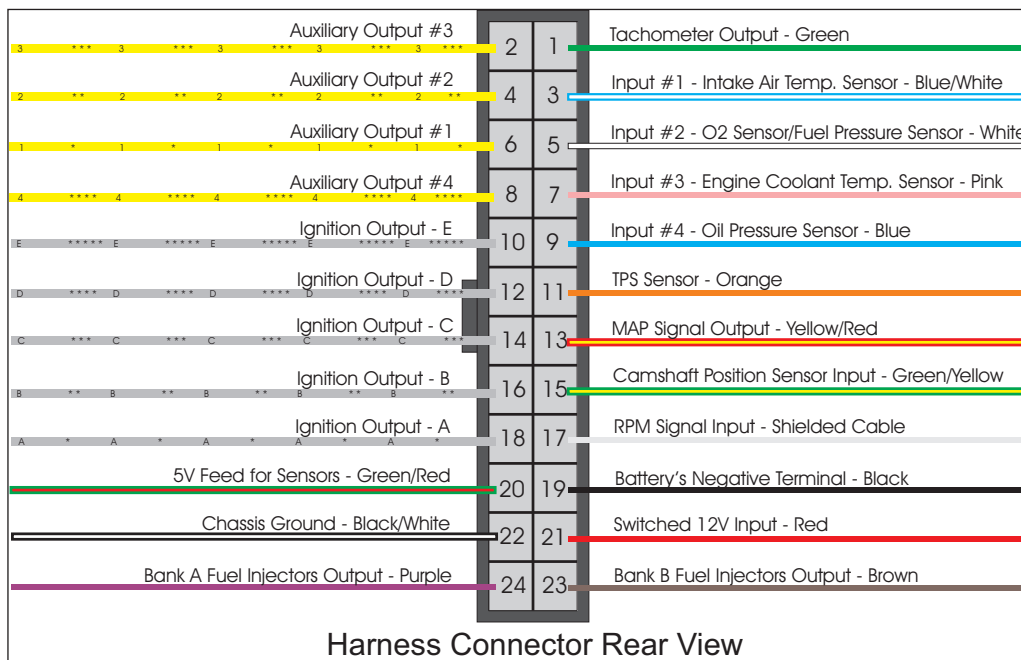

Harness Connector Rear View

5.2 Auxiliary harness connections (FT400 only)

Wire Color	Pin	Connection	Note
White #1	1	O2 sensor input	Connected to a wideband lambda O2 conditioner analog output or to a narrowband O2 sensor.
Gray – F	2	Ignition output F	
Orange #2	3	Electronic throttle TPS 2	When used with electronic throttle, it must be connected to the throttle's TPS 2.
Yellow #7	4	Auxiliary output #7	It must be configured prior to the installation.
White #2	5	Two-Step input	Two-step button (activated by negative signal).
Yellow #6	6	Auxiliary output #7	It must be configured prior to the installation.
White #3	7	A/C button input	Air conditioning actuation signal. It must be connected to the A/C button on the dashboard. The actuation polarity can be configured.
Yellow #5	8	Auxiliary output #7	It must be configured prior to the installation.
Black/white	9	Chassis ground	Power ground, connected to the vehicle's chassis or engine block, apart from the signal ground.
Orange/Blue #1	10	PEDAL signal #1	It must be connected to the pedal position sensor PEDAL1.
Green/Black	11	Throttle or pedal ground output	Connected to the TPS or the pedal sensor. When not using electronic throttle, connect this wire to battery negative.
Orange/Blue #2	12	PEDAL signal #2	It must be connected to the pedal position sensor PEDAL2.
Brown/White #2	13	Electronic throttle motor #1 Step motor (coil #1)	To constitute the MOTOR 1 wire, join both Brown/White wires and connect to the throttle.
Purple/White #2	14	Electronic throttle motor #2 Step motor (coil #2)	To constitute the MOTOR 2 wire, join both Purple/White wires and connect to the throttle.
Brown/White #1	15	Electronic throttle motor #1 Step motor (coil #1)	To constitute the MOTOR 1 wire, join both Brown/White wires and connect to the throttle.
Purple/White #1	16	Electronic throttle motor #2 Step motor (coil #2)	To constitute the MOTOR 2 wire, join both Purple/White wires and connect to the throttle.

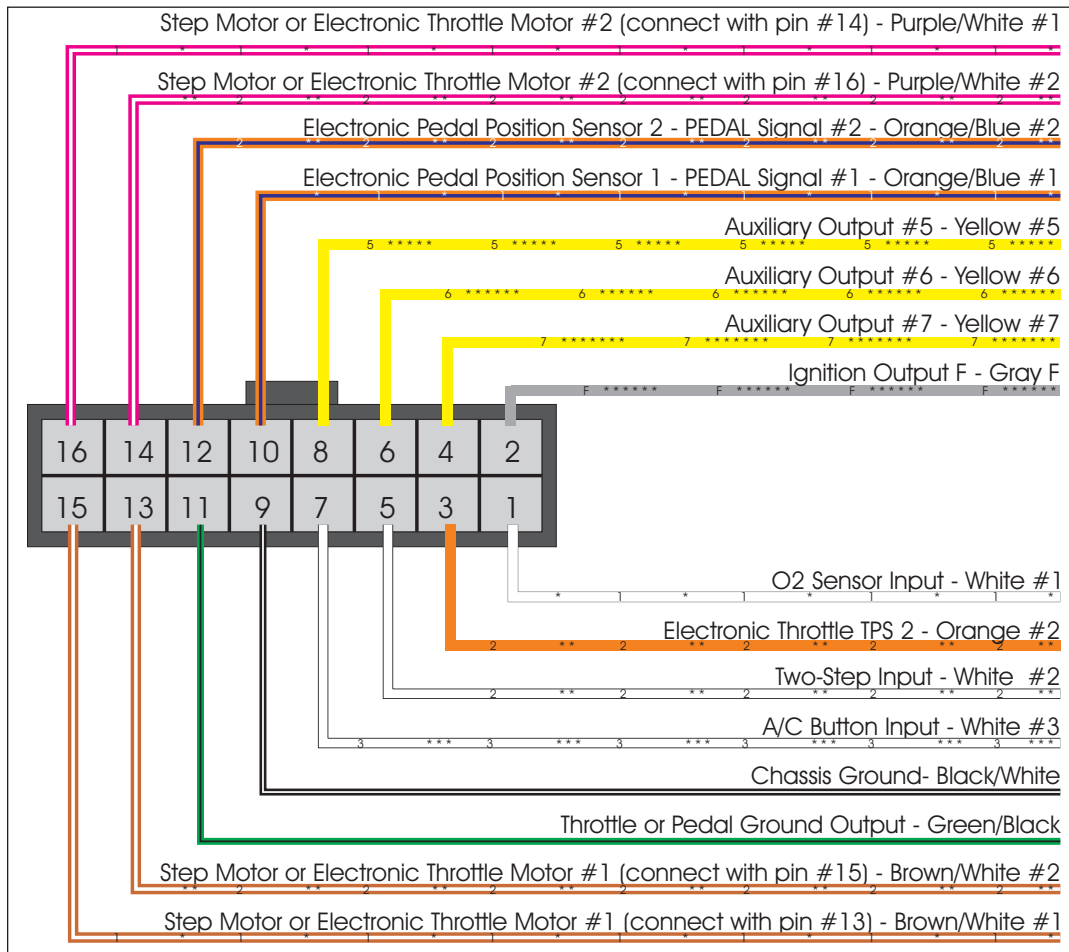

### Red wire – switched 12V

Being the 12V input to FuelTech ECU, this wire must be connected to a 12V straight from the ignition switch, no relay needed, just a 5A fuse. It cannot be split with a positive to coils or to fuel injectors.

- **12V for fuel injectors:** use a 14 AWG connected to a 40A relay. For up to 4 injectors, a 20A fuse is recommended. For up to 8 injectors, a 30A fuse is recommended. Low impedance injectors (below 10 ohms), when used without a Peak and Hold driver, require a 3,3ohms or 2,7ohms ballast resistor (20W or 25W), connected in series with each fuel injector to avoid damage to the ECU. But be aware that when using low impedance injectors with ballast resistor, each ECU injector output can drive only two injectors.
- **12V for hall effect distributor and sensors:** use a 24 AWG wire straight from the ignition switch. It can be Split with the ECU 12V. No relay needed. Do not split this wire with a 12V that feeds fuel injectors or coils. Examples: Hall Effect sensors, pressure sensors, etc.
- **12V for coils and fuel pump:** use a wire with at least 14 AWG connected to a 40A relay. Each relay can feed up to 2 fuel pumps or 5 coils. A 30A fuse is recommended. When using individual coils (COP), it is recommended a 70A or 80A relay.

NEVER split the 12V that feed injectors, coils or other accessories, because, after shutting the engine off, there's a risk of reverse current that may damage a sensor.

### Black wire – battery's negative

This wire is responsible for signal ground to the ECU so, it must be connected straight to the battery's negative terminal, with no seams. Under no hypothesis this wire can be connected to the vehicle chassis or split with the ECU black/white wire (power ground). This will cause electromagnetic interference and other problems hard to diagnose and to solve.

The black wire must have permanent contact with the battery's negative terminal, never being connected to switches, car alarms or others. To turn a FuelTech ECU off, the red wire should be switched on and off.

- **Negative for sensors (TPS, air temp., pressure, rpm, distributor, etc.):** It is vital to use sensors ground straight to the battery's negative terminal. Connecting them to chassis may cause electromagnetic interference, wrong readings or even damage to the sensors.
- **To attach the negative wires to the battery terminal** use ring terminals and avoid soldering them. A well crimped terminal has better resistance than a soldered one. Besides that, solder makes the seam stiffer, and less resistant to vibration, typically found on combustion engines.
- Use a crimping tool and insulate the wire with insulating tape or heat shrink tubing.

### White wire – power ground

This is the FuelTech ECU power ground wire. It must be connected to the vehicle chassis, with the same shield that goes from the chassis to the battery's negative terminal. Under no circumstance this wire can be connected straight to the battery's negative terminal or in the same point that the ECU black wire. This will cause electromagnetic interference and other problems hard to diagnose and to solve.

The black/white wire must have permanent contact with the vehicle chassis, never being connected to switches, car alarms or others. To turn a FuelTech ECU off, the red wire should be switched on and off.

- Power ground to ignition modules (SparkPRO, etc.), Peak and Hold drivers, relays and other accessories, must be connected to the same point, with the battery's shield on the chassis.
- An important point is that the battery's shield must be in good shape. It is strongly recommended to replace it in case of heavy wearing.
- A good test to check if the power grounds are with good connection is, using a tester, to measure the resistance between the battery's negative terminal and the chassis ground. Connect the red probe on the chassis point that the shield is connected and the black probe on the battery's negative. With the tester on the 200ohms range, the resistance measured must be below 1 ohm. Remember to touch both probes to check its resistance. This reading must be subtracted from the first reading to found the correct value.

- 1 - Shield connecting battery negative to chassis and engine;
- 2 - FT black wire Battery negative;
- 3 - Positive wire to alternator;

### 5.3 Main switch installation (optional) – important tips

Main switches are being used for a long time in competition vehicles for safety purposes in case of an accident. In just a few seconds, the entire power on the vehicle can be shut down, avoiding short circuits that can worsen the situation. And, just like any other electric accessory, there's a correct way to install it:

- The main switch cannot be connected to ground or power ground, under no circumstance!! This is the most common error done by electric installers and, usually costs hours of work to fix all the problems that it cause. All of this without counting the huge possibility of damaging all the electronic accessories on the vehicle. The main switch must ALWAYS control the battery's positive (12V).
- Battery's positive must be connected only to eh main switch, using a wire according to its manufacturer recommendation. The main switch output is the power 12V used to feed the ignition switch, relays, alternator, etc.
- Below is a schematic that shows the main switch connections. Please pay attention where the following wires are connected:

- 4 - Main switch;
- 5 - Ignition Switch;
- 6 - Switched 12V;

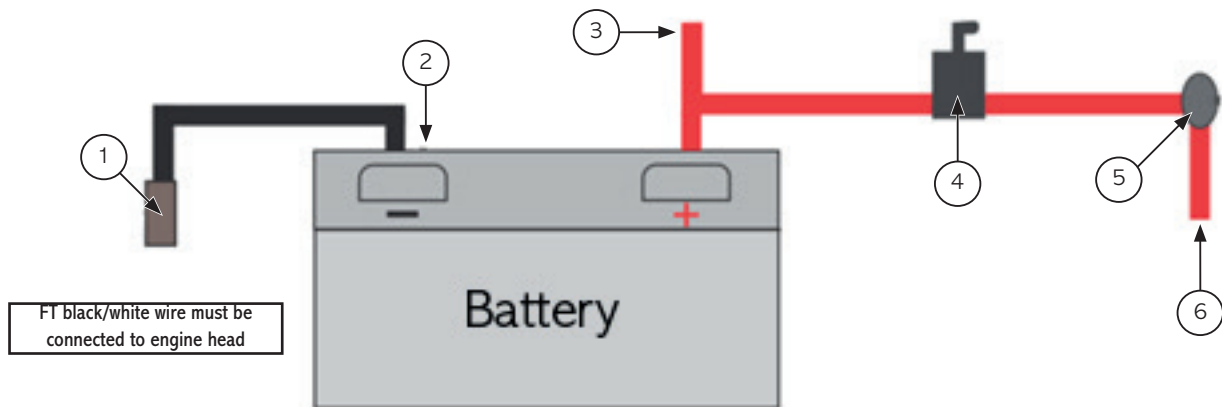

### 5.4 Built-in MAP sensor

This FuelTech ECU is equipped with a built-in MAP sensor on its back. It is recommended to use a polyurethane hose, found on pneumatic machines. The hose must have 4mm of internal diameter (and usually 6mm of external diameter). Silicone hoses are not recommended because they are easily bent and can block the vacuum way to FT ECU.

The hose must go from the FuelTech MAP sensor straight to the intake manifold after the throttle body, this means, any point between

the throttle body and the engine head. When using individual throttle bodies, it is necessary to connect each intake runner with "Y" connections, and then connect this to the ECU MAP sensor. Otherwise, the reading will be incorrect and unstable.

### 5.5 USB/CAN converter

On the rear side of the ECU there is a 4-way connector labeled CAN. This connection must be used with a USB/CAN Converter for communication with a PC and access to upgrades via internet.

## 6. Sensors

### 6.1 Intake air temperature sensor

The use of this sensor is optional, but when installed, it is automatically detected by the injection system. It allows to monitor the intake air temperature in real-time through the dashboard screen, verify the highest temperatures reached and compensate the mixture automatically based on air temperature.

With this sensor, it is possible to automatically compensate climate variations, from alterations in air temperature between daytime and night time, up to changes between seasons throughout the year. Any temperature difference requires a fine-tuned compensation in the mixture in order to keep the desired performance and efficiency.

The sensor that must be used is the Delphi / NTK (3.3kΩ at 20oC) standard, similar to the ones used by the Fiat lines, which has a metal structure and can be fixed to a nut welded to the intake manifold or at the pressurization.

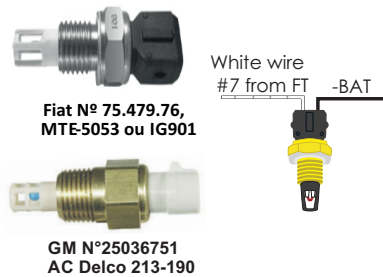

### 6.2 Engine temperature sensor

In cars with water cooling system, this sensor must be placed near to the engine cylinder head, preferably at an original part, in an originally injected engine. In cars with air cooling system, this sensor can be placed in the engine oil, as the fluid represents the temperature in which the engine works. The Delphi / NTK (3.3kΩ at 20oC) standard model must be used.

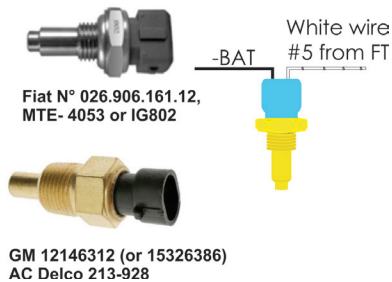

### 6.3 Fuel and oil pressure sensor – PS-10B sensor

The use of this sensor is optional, but when installed, it is automatically detected by the ECU. It allows to monitor fuel or oil pressure in real-time through the dashboard screen. With the Check Control function, it is possible to program pressure warnings. When installing this sensor, the ECU must be configured at the "Input/Output Setup" menu.

PS-10B characteristics:

- Output signal: 1 a 5V
- Electrical Connections:

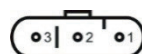

- o Pin 1: Battery's negative
- o Pin 2: Signal output
- o Pin 3: Switched 12V
- Connection: 1/8" NPT
- Pressure range: 0 a 145psi
- Input voltage: 12V
- Stainless steel body and IP67
- Accuracy (including nonlinearity, hysteresis, and repeatability): +/- 0.5% at maximum readings range.



### 6.4 Throttle position sensor (TPS)

The Throttle Position Sensor (TPS) is a potentiometer placed on the throttle body in order to inform its angular position. The TPS is the main sensor in the injection system when used in an aspirated engine without steady vacuum. When the engine is an aspirated by MAP, or Turbo by MAP, the TPS can be used to regulate the idle, the acceleration enrichment and the deceleration fuel cut-off.

In special cases, the engine can run without this sensor, but all the functions above mentioned will be performed by the MAP (with prejudice to fine-tune adjustment details).

All throttle bodies come with a TPS, and it is recommended that the original TPS is used, as its fixation and flow are in perfect fit to the part it came with. In any event, FuelTech products are compatible with any TPS sensor, as they have calibration functions.

### 6.5 Crankshaft position sensor (CKP)

In order to control fuel injection and ignition, the module can be connected to a variety of sensor types: distributors with Hall sensor or crankshaft trigger wheels with inductive or Hall Effect sensors. With any of these options, the injection will read the exact position of the engine and of the ignition control system as a whole.

#### Distributor

To read the RPM signal through a distributor, it should use a Hall Effect sensor (3-wires) and have the same number of windows as the number of cylinders.



Hall Effect distributor - VW Fox, Golf (EA-

On VW AP engines, it is possible to use the distributor from the Gol Mi (with a bigger window) or the distributors with the same window as the older model of the Gol GTi, the older model of the Golf, and other cars with LE-Jetronic fuel injection system.

On GM engines Family I (Corsa) and Family II (Vectra 8V and Calibra 16V), it is possible to use the distributor from vehicles that had electronic fuel injection Le-Jetronic system (Monza, Kadett GSi, Vectra up to 1996) or from the GM Corsa with 3 wires.

## Crankshaft trigger wheel – fabrication and installation

The crankshaft trigger wheel is responsible for informing the exact position of the crankshaft to the electronic ignition management system, in such a way that this system is able to determine the ignition timing in the engine. The trigger wheel is affixed to the crankshaft, outside or inside the engine block, with a specific alignment. Usually, the Crankshaft Trigger Wheels placed on the outside of the block are put in front of the engine, by the front crankshaft pulley, or in the rear of the engine, by the flywheel. There are many types of Trigger Wheels, but the compatible ones are mentioned below:

**60-2:** this is, in general, the most used type of trigger wheel. It is a wheel with 58 teeth and a gap (fault point) equivalent to two missing teeth, therefore called “60-2”. This trigger wheel is found in most Chevrolet (Corsa, Vectra, Omega, etc.), VW (Golf, AP TotalFlex, etc.), Fiat (Marea, Uno, Palio, etc.), Audi (A3, A4, etc.) and Renault (Clio, Scènic, etc.) models, among other car makers. Ford Flex models with Marelli injection use this type of trigger wheel also. Some VW Gol models are equipped with magnetic pickup studs. There are 58 studs, with 2 missing teeth (60-2). Its alignment is 15 teeth from TDC.

**36-2:** standard in Toyota engines, being 34 teeth and a gap equivalent to two missing teeth.

**36-1:** has 35 teeth and a gap equivalent to one missing tooth. It can be found in all Ford vehicle lines, with 4 or 6 cylinders (except the Flex models with Marelli injection, which use the 60-2 trigger wheel).

**12-tooth:** this type is used by AEM's Engine Position Module (EPM) distributor. In this case, the cam sensor from the EPM must be used. This distributor has 24 teeth, but as it rotates half-way for each full engine RPM, there will only be 12 teeth per RPM. Setup the Ignition with 12 tooth and the 1st tooth alignment



## AEM EPM module – electrical connections

- Red: Switched 12V
- Black: Battery's negative
- Yellow: Shielded cable's white wire, Hall RPM signal
- White: Green/Yellow Wire from FT, Hall CAM signal



### WARNING:

*In some cases, the rpm sensor of these AEM distributors is a little loosen. It is recommended that, before the installation on the engine, the sensor be checked to ensure it is well fixed to the distributor. If there is any clearance or the sensor is loosen, the ignition timing can vary around 10° and damage the engine or make it misfire.*

**2, 3, 4, 8-tooth:** options available according to the number of engine cylinders. When having these trigger wheels, the use of a camshaft position sensor is mandatory, in order to maintain the synchronization of the parts. Also, the teeth must be equidistant. They can be found in models such as Subaru, Mitsubishi Lancer and 3000GT, GM S10 Vortec V6, etc.



### NOTE:

*This crank trigger will only work with a single tooth cam sync. On stock engines it is needed to remove the smaller tooth from the cam trigger wheel.*

**30-1, 24-1 and 12-1 tooth:** These are less common types, but they are perfectly compatible. These trigger wheels can operate without a camshaft position sensor, as they have a gap that indicates the TDC on cylinder 1.

In order to correctly inform the engine position to the injection module, it is necessary that the injection has the right information about the alignment of the trigger wheel in relation to the TDC on cylinder 1.

The image below shows a 60-2 trigger wheel with the sensor aligned on the 15th tooth after gap. In this image, for example, the engine is on the TDC on cylinder 1. Notice that the RPM is clockwise, and therefore, the TDC on cylinder 1 is set 15 teeth after the sensor passes the gap. That is exactly the number of teeth that must be informed to the injection upon its configuration.

Sometimes a trigger wheel has to be fabricated because of the type or size used, as it happens with motorcycles, for example. In such cases, it is important to observe that the size of the teeth on the fabricated trigger wheel must be equal to the size of the space in between them. The minimum diameter for the fabrication of a 60-2 trigger wheel is 125mm (5"). For 36-1 trigger wheels, the minimum diameter recommended is 100mm (4"). Trigger wheels with smaller diameters can be fabricated, but reading errors may occur and the engine may not work.

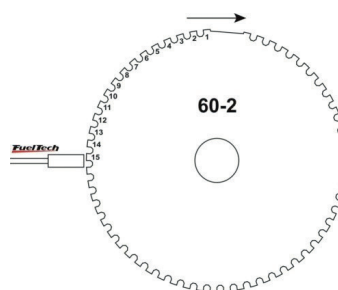

## Crankshaft trigger sensor

When controlling the ignition with a trigger wheel, it is necessary to have a sensor that reads the signal from its teeth and informs the engine position to the injection. There are two types of crankshaft trigger sensors:



**Magnetic sensor:** this is the type that is most commonly used in cars nowadays, especially with 60-2 and 36-1 trigger wheels. One of its main characteristics is that it does not receive 12V or 5V feed, it only generates an electromagnetic signal based on induction. It might have 2 or 3 wires (the third wire is an electromagnetic shield).

**Hall effect sensor:** it is usually found on 2, 3 and 4-tooth trigger wheels and some 36-1 and 60-2 types. It receives a 5V or 12V feed and emits a square wave signal. It invariably has 3 pins: feed, negative and signal.

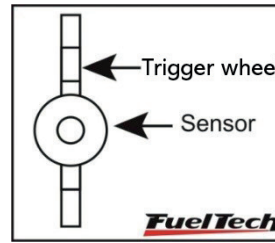

The crank Wheel should be aligned with the sensor

Table of crankshaft trigger sensor models

Sensor	Type	Cars in which this sensor is usually found	Connection of sensor pins to the injection system
Bosch 3 wires	Magnetic	Chevrolet: Corsa 8V MPFI; Omega 2.2, 4.1 and 2.0 (ethanol); S10 2.2; Astra; Kadett MPFI; Vectra; Calibra. VW: Golf; Passat; Alfa: 164 3.0.	Pin 1: Shielded cable's white wire Pin 2: Shield Pin 3: Battery's negative
Bosch 3 wires	Magnetic	Chevrolet: Omega 2.0 (gasoline) and 3.0; Corsa 16V/GSi, Tigra. Fiat: Marea 5 cylinders. Citroën: ZX 2.0; Xantia 2.0. Peugeot: 306 2.0 16V; 405MI.	Pin 1: Shield Pin 2: Shielded cable's white wire Pin 3: Battery's negative
Ford 2 wires	Magnetic	Ford: Zetec, Ranger V6.	Pin 1: Shielded cable's white wire Pin 2: Shield
Siemens 2 wires	Magnetic	Renault Clio, Scenic	Pin A: Shielded cable's white wire Pin B: Shield
Delphi 3 wires (3-teeth wheel)	Hall	GM: S10 4.3 V6 - Vortec	Pin A: Switched 12V Pin B: Battery's negative Pin C: Shielded cable's white wire
Denso (Suzuki Motorcycles)	Magnetic	Suzuki Hayabusa and Suzuki SRAD.	Pin 1: Shielded cable's white wire Pin 2: Shield
Mitsubishi 1.6 16V (2-teeth)	Hall		Pin 1: Black: Battery's negative Pin 2: Brown: Shielded cable's white wire Pin 3: Red: 5V from green/red wire
VW / Audi 20V 3 wires Bosch - 0261210148	Magnetic	All VW / Audi 1.8 20V. VW: Golf 1.6 and 2.0; Bora 1.6.	Pin 1: Battery's negative Pin 2: Shield Pin 3: Shielded cable's white wire
VW Gol GTi Hall (3 wires)	Hall	Gol GTi 16V	Pin 1: 5V from green/red wire Pin 2: Shielded cable's white wire Pin 3: Battery's negative
Denso 3 wires	Hall	Honda Civic Si	Pin 1: Switched 12V Pin 2: Shield Pin 3: Shielded cable's white wire

\* If the inductive sensors are not capturing the RPM signal, the white wire and the shield (both from the shielded cable) must be inverted.

A very simple test using a tester can identify if a Crankshaft Trigger Sensor is an inductive or a Hall Effect sensor. Turn the tester on the resistance measurement mode at a 2000Ω scale and connect its probes to the sensor's pins. Test pin 1 with the other two. If a resistance of approximately 600Ω is found, the sensor tested is of inductive type. If no resistance is found among any of the pins, or if the resistance found is much higher than 600Ω, it is either a Hall Effect sensor, or an inductive sensor with a broken coil. Notice that, when finding the resistance between pins 2 and 3, for example, pin 1 must be connected to the battery's negative terminal and the other 2 to FT shielded cable. If the module does not capture the signal, invert the white and shield wires connections.

When the test above does not present any results, the sensor is probably of Hall Effect type. To test it and find its pinning, turn the tester on the diodes measurement mode and connect its probes to the sensor's pins. Test every possible position, and then, invert the probes and test it again. When the measurement shown is approximately 0.600V, the red probe will be on the pin that must be connected to the battery's negative terminal, and the black probe will be on the sensor's signal pin. The third pin must be connected to the battery's positive terminal.



## 6.6 Camshaft position sensor

When using a crankshaft trigger wheel and individual ignition coils, it is possible to control ignition in a sequential manner. In this case, a camshaft position sensor is needed, as it informs the exact moment when cylinder 1 is on combustion TDC. Installation and alignment of a camshaft position sensor are very simple procedures, and the only requirement is that the sensor emits a pulse to the injection a little before reaching the TDC on cylinder 1.

Table of camshaft position sensor models

Sensor	Type	Cars in which this sensor is usually found	Connection of Sensor Pins to the Injection System
Bosch 3 wires	Hall	Chevrolet: Calibra; Vectra GSi; Omega 4.1. Citroën: ZX 2.0; Xantia 2.0. Peugeot: 306 2.0 16V; 405MI.	Pin 1: Switched 12V Pin 2: Green/yellow wire Pin 3: Battery's negative terminal
Bosch 3 wires	Hall	Fiat: Marea 5 cylinders. Chevrolet: Astra 16V; Zafira 16V.	Pin 1: 5V from green/red wire Pin 2: Green/yellow wire Pin 3: Battery's negative terminal
Bosch 3 wires	Hall	Chevrolet: Corsa 16V; Tigra.	Pin 15: Switched 12V Pin 6: Green/yellow wire Pin 17: Battery's negative terminal
Delphi (Camshaft Position)	Hall	GM: S10 4.3 V6.	Pin A: Battery's negative terminal Pin B: Green/yellow wire Pin C: Switched 12V
Bosch 3 wires	Magnetic	Alfa: 164 6 cylinders.	Pin 1: Battery's negative terminal. Pin 2: Green/yellow wire. Pin 3: Battery's negative terminal.
Ford 2 wires	Magnetic	Ford: Zetec, Ranger V6.	Pin 1: Green/yellow wire Pin 2: Battery's negative terminal
VW / Audi 20V 3 wires	Hall	All VW / Audi 1.8 20V.	Pin 1: 5V from green/red wire Pin 2: Green/yellow wire Pin 3: Battery's negative terminal
Denso (Suzuki Motorcycles)	Magnetic	Suzuki Hayabusa and Suzuki SRAD.	Pin 1: Green/yellow wire Pin 2: Battery's negative terminal
3 wires (close the sensor's smallest opening with an adhesive tape)	optical	Mitsubishi 1.6 16V	Pin 1: Black: Battery's negative terminal Pin 2: White/Red: Green/yellow wire Pin 3: (Red wire): 5V from green/red wire
Denso 3 wires	Hall	Honda Civic Si	Pin 1: Switched 12V Pin 2: Battery's negative terminal Pin 3: Green/yellow wire
3 wires (close the sensor's smallest opening with an adhesive tape)	optical	Mitsubishi 1.6 16V	Pin 1: Black: Battery's negative terminal Pin 2: White/Red: Green/yellow wire Pin 3: (Red wire): 5V from green/red wire
Denso 3 wires	Hall	Honda Civic Si	Pin 1: Switched 12V Pin 2: Battery's negative terminal Pin 3: Green/yellow wire

## 6.7 O2 sensor

### Wideband O2 sensor

The use of wideband lambda sensors on FT input requires an external conditioner (WB-O2 Slim or WB-O2 Datalogger). FT400's O2 sensor input (white wire #1), or FT350 (blue wire), must be connected to the conditioner's analog output. It is important to verify the measurement range of conditioner analog output, as this will be informed during the configuration of FT400's O2 input (0,65-1,30, 0,65-4,00 or 0,65 to 9,99).

Wire color	4-wire O2 sensor	3-wire O2 sensor	1-wire O2 sensor
Black	Signal output	Signal output	Signal output
White (2 wires)	Switched 12V and ground (connect one wire onto the 12V and the other to ground – there is no polarity)		Not featured
Gray	Battery's negative terminal	Not featured	Not featured

### Narrowband O2 sensor

Although less precise than the wideband lambda sensor, narrowband (or conventional) O2 sensors can be connected to FT400's input (white wire #1), or FT350 (blue wire), for the display of values (in Volts) at the Dashboard and at the Diagnostic Panel. Conventional lambda sensors usually follow a standard set of colors, facilitating the wiring. The table below shows the wiring instructions based on the color scheme generally used for O2 sensor wires:

As a general rule, if there are two wires with the same color, one is the switched 12V and the other is the ground. After connecting the O2 sensor to the FT400, the O2 sensor input must be configured as instructed in chapter 12.4 in this manual.

## 7. Fuel injectors

Every injection output can drive up to 6 high impedance fuel injectors (resistance greater than 10 ohms) or up to 2 low impedance fuel injectors (resistance lower than 10 ohms) with power resistors. There is no need for auxiliary modules.

fuel injectors need to be driven, it is necessary to use FuelTech Peak and Hold module. Check the Peak and Hold instructions manual on our website for information on electrical connection.

### 7.1 High impedance fuel injectors

The diagram below shows the direct connection of six high impedance fuel injectors to one of the injection's output. As it is, up to 12 fuel injectors can be controlled with no need for auxiliary modules (6 on each output). It is also possible to connect a lesser number of fuel injectors per output.

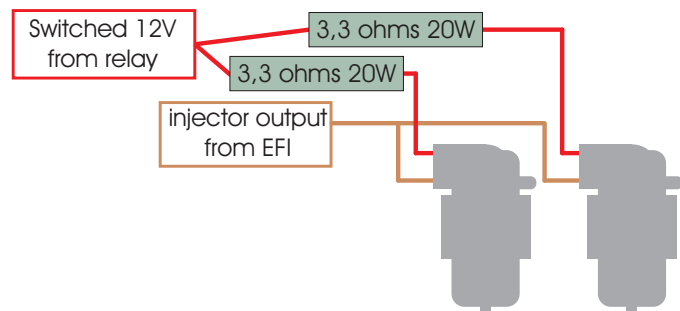
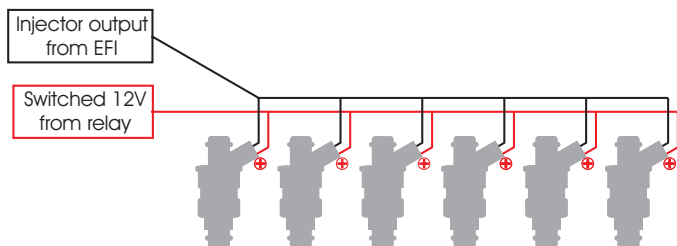

### 7.2 Low impedance fuel injectors

The next diagram shows the connection of two low impedance fuel injectors to one of the injection's output, with the use of power resistors. Being so, up to four low impedance fuel injectors can be controlled with no need for an auxiliary module. If more low impedance

Low impedance fuel injectors may only be installed along with resistors when used as supplementary injectors on turbocharged engines. If the use of low impedance fuel injectors is needed to control the low charge and the engine's aspirated phase, the use of FuelTech Peak and Hold module is highly recommended, as the control of the current it features makes the driving of the injectors much more precise.

FuelTech injections are compatible to any Peak and Hold module in the market.

## 8. Ignition

FuelTech FT400 has six ignition outputs, FT350 has 5 ignition outputs. They are used according to the specific requirements of each project. Ignition can be controlled with a distributor or a crankshaft trigger wheel.

### 8.1 Ignition with distributor

When using the injection along with a distributor, only the ignition output "A" shall be used. The wire must drive a coil with an integrated ignition module or an ignition power module.

#### Coil with integrated ignition module

These coils have at least 3 input wires and only one output for ignition cable, such as the one used in the VW Gol Mi, with 3 wires. It is recommended to set the charge time (Dwell) around 3,60ms in order to protect the coils from overcharge. When using this type of ignition coils, the "Ignition Output" parameter must be configured as "Falling edge (inductive)". If the output is not correctly selected, the ignition coil will be damaged in seconds.

The wiring for this type of ignition coil must be as follows:

- Pin 1: Power ground (chassis ground)
- Pin 2: FuelTech ignition output "A"
- Pin 3: Switched 12V supply



Bosch Ignition Coil F000 Z50 104  
Integrated ignition module

#### FuelTech SparkPRO-1 with coil without ignition module

FuelTech SparkPRO-1 module is a high-energy inductive ignition with an excellent benefit-cost ratio, and it can be used with any regular 2-wire ignition coil (without internal ignition). It is recommended to use ignition coils with the lowest resistance possible as the primary, like the 2-wire ignition coil from VW AP Mi (Bosch Code: F 000 Z50 105), in order to have a better use of SparkPRO-1's performance. The primary coil's minimum resistance must be 0.7 ohms; a lower resistance will damage the SparkPRO.

Notice also that this module must be placed the closest possible to the ignition coil.



**Warning about the SparkPRO-1: An excessive charge time (Dwell) can damage the SparkPRO and the coil. It is recommended to use a 3,60ms Dwell and watch its temperature during normal engine operation. If the temperature rises greatly, immediately lower the Dwell. Be very careful!**



#### IMPORTANT:

**The Ignition output must be configured as "Falling edge (inductive)". If the output is not correctly selected, the ignition coil will be damaged in seconds!**

#### Capacitive discharge ignition (MSD 6A, 7AL, Crane, Mallory)

FuelTech ignition output must be connected to the power ignition module (usually, the white wire). The installation of ignition modules must always be done exactly as indicated by its manufacturer in the instructions manual, and it will only have the capture of the ignition signal coming from FuelTech. Use the ignition coil recommended by the manufacturer of the ignition module.

Important notes:

- The module must be placed the closest possible to the ignition coil, and never inside the car, in order to avoid the risk of interferences on electronic devices.
- The length of the wires that connect the ignition module to the ignition coil must be the shortest possible.
- On "Ignition Setup", select the output "Rise (CDI)".
- It is not possible to control the ignition Dwell when using this type of module.

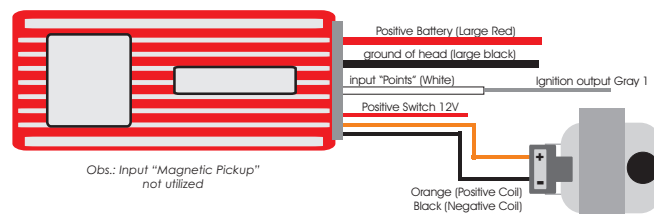

### 8.2 Ignition with crankshaft trigger wheel

In a distributorless ignition, a static ignition system, with double or individual coils per cylinder, is needed. In this system, the coils are switched by different outputs, depending on the cylinder to which they are connected. The ignition outputs always pulse in a sequential manner from "A" to "F", therefore these outputs must be connected to the coils in accordance to the engine's ignition sequence. Find below examples of some engines' ignition sequence and the connection to some coils.



#### IMPORTANT:

- **The ignition output F is located on FT400's Auxiliary Cable.**
- **For 6 cyl engines using FT350, splice ignition output C were its stated output F.**



## Double ignition coils – electrical wiring table

When there are double ignition coils, it is necessary that each ignition output switches more than one coil, as shown in the diagrams below:  
 4-Cylinder Engines: when having double coils, use the ignition sequence shown in the previous chapter, exchanging the output C to A, and the output D to B

### 6-cylinder engines: GM inline engine (Opala and Omega), VW VR6, Ford inline engine and BMW inline engine

Firing order: **1-5-3-6-2-4**                      **1**    **5**    **3**    **6**    **2**    **4**  
 Coils' ignition sequence:                      **A**    **B**    **C**    **A**    **B**    **C**

The cylinders 1 and 6 are connected to coil A, the cylinders 2 and 5 are connected to coil B, and the cylinders 3 and 4 are connected to coil C.

### 6-cylinder engines: GM V6 (S10 / Blazer 4.3)

Firing order: **1-6-5-4-3-2**                      **1**    **6**    **5**    **4**    **3**    **2**  
 Coils' ignition sequence:                      **A**    **B**    **C**    **A**    **B**    **C**

The cylinders 1 and 4 are connected to coil A, the cylinders 3 and 6 are connected to coil B, and the cylinders 2 and 5 are connected to coil C.

### 6-cylinder engines: Ford Ranger V6

Firing order: **1-4-2-5-3-6**                      **1**    **4**    **2**    **5**    **3**    **6**  
 Coils' ignition sequence:                      **A**    **B**    **C**    **A**    **B**    **C**

The cylinders 1 and 5 are connected to coil A, the cylinders 3 and 4 are connected to coil B, and the cylinders 2 and 6 are connected to coil C.

### 8-cylinder engines: Chevrolet V8 (most of the engines)

Firing order: **1-8-4-3-6-5-7-2**                      **1**    **8**    **4**    **3**    **6**    **5**    **7**    **2**  
 Coils' ignition sequence:                      **A**    **B**    **C**    **D**    **A**    **B**    **C**    **D**

The cylinders 1 and 6 are connected to coil A, the cylinders 5 and 8 are connected to coil B, the cylinders 4 and 7 are connected to coil C, and the cylinders 2 and 3 are switched on coil D.

### 8-cylinder engines: Ford 302, 355, 390, 429, 460

Firing order: **1-5-4-2-6-3-7-8**                      **1**    **5**    **4**    **2**    **6**    **3**    **7**    **8**  
 Coils' ignition sequence:                      **A**    **B**    **C**    **D**    **A**    **B**    **C**    **D**

### 8-cylinder engines: Ford 351, 400 and Porsche 928

Firing order: **1-3-7-2-6-5-4-8**                      **1**    **3**    **7**    **2**    **6**    **5**    **4**    **8**  
 Coils' ignition sequence:                      **A**    **B**    **C**    **D**    **A**    **B**    **C**    **D**

### 8-cylinder engines: Mercedes-Benz

Firing order: **1-5-4-8-6-3-7-2**                      **1**    **5**    **4**    **8**    **6**    **3**    **7**    **2**  
 Coils' ignition sequence:                      **A**    **B**    **C**    **D**    **A**    **B**    **C**    **D**

## Double ignition coils wiring table

Ignition Coil	Type	Cars in which it is usually found	Wiring
Bosch 4-cylinder (3 wires) F 000 ZS0 213 F 000 ZS0 222 0 221 503 011	No internal ignition	Celta, Corsa, Gol Flex, Meriva, Montana Vectra 16V	Pin 1a (A): Ignition power (from SparkPRO channel switched by injection's gray "B" wire) Pin 15 (B): Switched 12V – from relay Pin 1b (C): Ignition power (from SparkPRO channel switched by injection's gray "A" wire)
Bosch 4-cylinder (3 wires) F 000 ZS0 203 F 000 ZS0 205	No internal ignition	Astra, Kadett, Ipanema, Vectra 8V, Zafira	Pin 1: Ignition power (from SparkPRO channel switched by injection's gray "A" wire) Pin 2: Switched 12V – from relay Pin 3: Ignition power (from SparkPRO channel switched by injection's gray "B" wire)

Ignition Coil	Type	Cars in which it is usually found	Wiring
Delphi 4-cylinder (round)	Integrated ignition module	GM Corsa MPFI (from 1998 to 2002)	Pin A: Gray - B (cylinders 2 and 3) Pin B: Gray - A (cylinders 1 and 4) Pin C: Ground Pin D: Switched 12V – from relay
Delphi 4-cylinder (square)	Integrated ignition module	GM Corsa MPFI (up to 1997)	Pin 1: Switched 12V – from relay Pin 2: Ground Pin 3: Gray - A (cylinders 1 and 4) Pin 4: Gray - B (cylinders 2 and 3)
Bosch 4-cylinder (4 wires) 032 905 106 B	Integrated ignition module	VW Golf, Bora; Audi A3 and A4; Seat Ibiza and Cordoba. (Ignition Output Voltage must be configured to 5V)	Pin 1: Gray - A (cylinders 1 and 4) Pin 2: Switched 12V – from relay Pin 3: Gray - B (cylinders 2 and 3) Pin 4: Ground
Bosch 6-cylinder 021 905 106C 0986221015 ZSE 013	Integrated ignition module	VW Passat/Golf VR6	Pin 1: Ground Pin 2: Gray - B (cylinder 2 and 5) Pin 3: Gray - C (cylinder 3 and 4) Pin 4: Gray - A (cylinder 1 and 6) Pin 5: Switched 12V – from relay
Eldor – 4-cylinder (6 wires – 6 channel) 06A 905 097 06A 905 104	Integrated ignition module Individual cylinder firing	Bora, Jetta, New Beetle, Polo	Pin 1: Ground Pin 2: Gray - C (cylinder 4) Pin 3: Gray - B (cylinder 3) Pin 4: Gray - D (cylinder 2) Pin 5: Gray - A (cylinder 1) Pin 6: Switched 12V – from relay
Bosch 6-cylinder 0 221 503 008	No internal ignition	GM Omega 4.1, Ford V6	Pin 1: Ignition power (from SparkPRO channel switched by injection's gray "C" wire) Pin 2: Ignition power (from SparkPRO channel switched by injection's gray "B" wire) Pin 3: Ignition power (from SparkPRO channel switched by injection's gray "A" wire) Pin 4: Switched 12V – from relay

## 9. Auxiliary outputs

The current capacity of these outputs is 0.5A, and therefore they can drive solenoids or relays with 25Ω of minimum resistance. The installation of a fuse equivalent to the charge is recommended.

The auxiliary outputs have an overcharge protection system, with automatic cut-off of current and the activation of charges (lamps, relays, etc.) always originated from the negative terminal. Thus, the positive terminal must be connected to a switched 12V.

The yellow wires numbered 1 to 4 are the configurable auxiliary outputs.

Each output must be configured in accordance to its function. For more information about the outputs programming, see chapter 15 in this manual. Notice that the configuration is not lost when the output is deactivated.

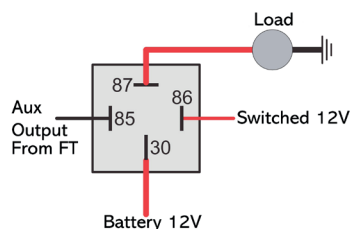

### 9.1 Thematic fan

This output is responsible for switching an electric fan according to the module's settings. The relay used must be adequate to the electric fan's current (50A, for example).

The relay is switched by negative (sourced by the output), and the positive a switched 12V.

Important Note: the electric fan must not be connected directly to the auxiliary output without the use of a relay; otherwise, the output will be damaged.

### 9.2 Air conditioning (FT400 only)

This auxiliary output option allows for a much more intelligent control of the vehicle's air conditioning compressor, as the FT400 controls its actuation only when the engine is already on and the idle speed has stabilized and turns off the air conditioning when the valve exceeds a predetermined value (a resource commonly used in low-powered engines).

In order to have the air conditioning control, the A/C Signal Input (white wire #3 – pin 7) from the auxiliary cable must be connected to the A/C button on the dashboard.

The air conditioning will remain actuated as long as the A/C Signal Input receives signal from the button. The signal polarity can be chosen and it varies depending on the installation.



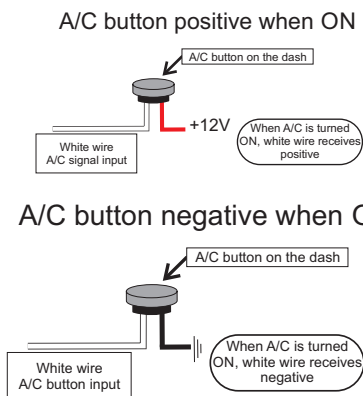

### 9.3 Shift alert

This function activates an external shift light and works by sending negative when turned on. Any of the options below can be used:

- 12V light bulb up to 5W: switched 12V directly connected to the light bulb and the negative connected to the auxiliary output.
- Light bulb over 5W: use a relay to switch the light bulb.
- LED working as a Shift Light, which must be connected with a serial resistance (if used in 12V, resistance from 390Ω to 1kΩ) to the switched 12V.
- Any “Pen” Shift Light – working in the same way as a light bulb.

### 9.4 Fuel pump

The fuel pump switching must be done through a relay dimensioned in accordance to the pump’s working current. The output sends out negative to activate the relay, which stays activated for 6 seconds and turns itself off if the injection does not receive any RPM signal. When the injection captures the RPM signal, it activates the fuel pump once again.

### 9.5 Variable camshaft control/Powerglide gears

The camshaft control systems that use solenoid valve type NA/NF such as Honda’s VTEC can be controlled through this output. The user only needs to inform the solenoid’s turn on RPM.

It is important to notice that the impedance of the variable control system’s solenoid must respect the auxiliary output limits, which requires a minimum impedance of 25Ω, or the use of a relay. For valve timing control systems switched by PWM (such as Toyota’s VVTi), it is possible to manage it through the Boost Control function, as long as its characteristics (power, current, etc.) are within the auxiliary output limits.

This resource can also be used to switch the control solenoid from the 2-speed automatic gear control, Powerglide type. Inform the RPM to turn on the solenoid responsible for engaging the second gear.

### 9.6 Progressive nitrous control

This function drives the solenoids used for the injection of nitrous oxide in the engine. As these solenoids have high power (90W) and low impedance (~1.6Ω), they cannot be connected directly to the auxiliary output; the use of a Solid state relay is necessary to drive the solenoid(s).

The cable pointed by the arrow in the image beside is an auxiliary output that must be configured as “Progressive Nitrous Control” to work properly.

There are two ways of using the nitrous control: with or without fuel injection through the fogger. The first option is also the most used one, in which the fogger injects both nitrous oxide and fuel. In the second option, the fogger only injects nitrous, so called “dry nitrous”. Fuel enrichment is managed by the ECU, increasing injection times based on what has been programmed. The dry nitrous system has reached better results in tests, giving the engine a more linear power than the first option. It is important to clarify that in order to use the dry nitrous system, the fuel injectors must be dimensioned for the power reached with the nitrous, and otherwise will not be able to feed the engine.

It is recommended that one of the injection maps is left only for nitrous when using a dry nitrous system, because injection timing adjustments – different from the ones usually made for engines that don’t use nitrous – must be set on the compensation map based on RPM.

There is a difference in the operation of solenoids that control nitrous injection and the ones that control fuel injection: nitrous solenoid starts pulsing after 5%; fuel solenoid only pulses after 20%. Variations may occur among solenoids from different brands/manufacturers.

When applying the conventional nitrous control, one must start with a minimum injection time of 20%, but when using dry nitrous, it is possible to start with 5%, as the injectors – and not the solenoid – will control fuel injection.

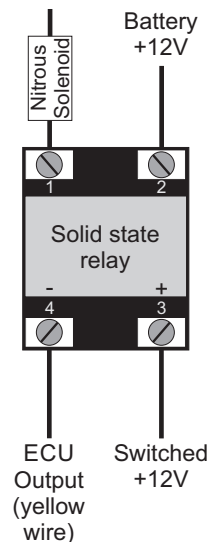

### 9.7 Boost control

This auxiliary output configuration allows the driving of a boost pressure control solenoid. FuelTech recommends using a 3-way N75 solenoid, found in the original 4 and 5-cylinder VW/Audi Turbo models, which can be directly switched through the auxiliary output.

Such solenoid valve controls the pressure on the top and bottom parts of the wastegate valve, changing the pressure with which the latter opens. FuelTech does not recommend the use of this solenoid when reaching pressure levels above 36psi, as leakage may occur.



solenoid valve N75  
VW 058-906-283F

### Wastegate at the Exhaust Manifold

This type of valve is used on most cars with adapted turbo, in competitions, etc. With it, the longest connection from the N75 valve is left in open air, and the upper one is connected to the pressurization. The shortest side connection is attached to the wastegate bottom part. When the N75 is off, it allows the flow of pressure from the pressurization to the wastegate valve's bottom part. Being so, the maximum pressure allowed by the wastegate is limited by its spring. When activated, the N75 releases the pressure put on the wastegate bottom part to open air, which completely closes the communication between the exhaust manifold and the wastegate output, and allows the turbine to generate its maximum pressure, i.e., total pressure. The higher the counter pressure generated by the turbine at the exhaust manifold, the lower its maximum pressure is.

### Wastegate Integrated to the Turbine

This valve has a different operation system, as it relieves the boost pressure when pressure is put on its top part, which is the opposite of what happens to the wastegate installed at the exhaust manifold.

When the N75 is off, the top part of the wastegate receives pressure coming directly from the pressurization, therefore letting the turbine generate only as much pressure as the wastegate spring allows.

When activated, the solenoid alters the course of the pressure coming from the pressurization to open air, relieving the pressure put on the top part of the wastegate, which completely closes the passage of exhaust gases and makes the turbine generate maximum pressure.

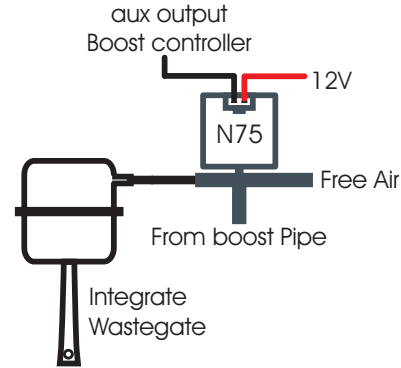
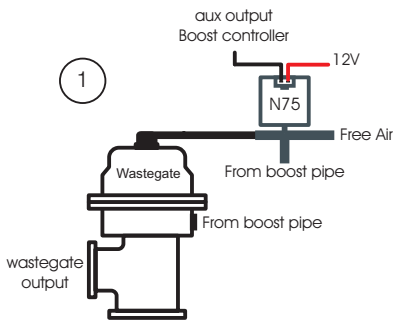

**IMPORTANT NOTE:**

Be very CAUTIOUS when using this resource. When values close to 100% boost have been programmed, the turbine may generate full pressure, which may cause engine damage if it has not been properly prepared to support the pressure levels reached.

## 10. Electronic throttle control – ETC (FT400 only)

FT400's electronic throttle control is very simple to install, as shown in the diagram below:

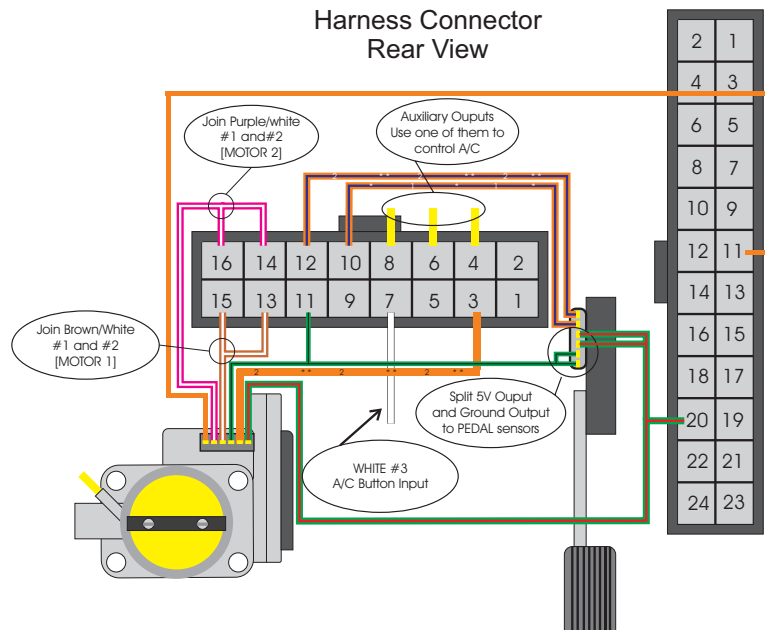

Notes about the diagram above:

- **Purple/White #1** and **Purple/White #2** wires must be spliced in order to form ETC's MOTOR 2 wire.
- **Brown/White #1** and **Brown/White #2** wires must be spliced in order to form ETC's MOTOR 1 wire.
- The **Green/Black** wire is a signal ground output for the throttle and pedal position sensors. It must be split and connected to both connectors.
- The **Green/Red** wire from the Main Cable is a 5V output and must be used to feed the throttle and pedal position sensors. It must be split and connected to both connectors.
- The **White** wire is the air conditioning button input. One of the **Yellow** wires must be configured to drive the air conditioning compressor relay. See chapter 8.2 for further information regarding these connections.

## 10.1 Wiring table – pedals and throttle bodies

Below you can find a wiring table for some throttle bodies. In case the model you use is not listed there contact FuelTech technical support for further assistance before the installation. It might be necessary to send your electronic throttle and pedal to FuelTech for parameter determination and inclusion onto the software.

On the first line of each throttle and pedal is the reference number found on the throttle. On the next line, there is a reference number marked as "FT400 Number", which must be inserted to the module menu, as advised in chapter 17.1 in this manual.

### Chevrolet Astra/Zafira 2.0 MPFi Flex 2004< – Fiat Marea 2.0 – 0280750153

FT400 number: 02F03406A1028122014013C

Throttle – Bosch				Pedal - Hella			
Pin 1	Motor 1	Pin 4	Motor 2	Pin 1	FT400 5V Out	Pin 4	FT400 GND Out
Pin 2	FT400 GND Out	Pin 5	TPS 2	Pin 2	FT400 5V Out	Pin 5	FT400 GND Out
Pin 3	FT400 5V Out	Pin 6	TPS 1	Pin 3	PEDAL 1	Pin 6	PEDAL 2

### Chevrolet Astra 2.0 Gas. e 2.0 16V Flex, Vectra 2.0 8V 2006< – Vectra/S10 2.4

Throttle 0280750237 (93338177) FT400 number: 06608C0B7100712201401F7

Chevrolet Corsa 1.8 Flex – Throttle 0280750214 FT400 number: 05905E0D4101B12201401ED

Audi A4, A6, A8, VW Passat 2.8 – Throttle 0280750030 FT400 number: 05B0DC05F101912201401F6

Throttle – Bosch				Pedal - Bosch			
Pin 1	TPS 1	Pin 4	TPS 2	Pin 1	FT400 5V Out	Pin 4	FT400 GND Out
Pin 2	FT400 5V Out	Pin 5	Motor 2	Pin 2	FT400 5V Out	Pin 5	FT400 GND Out
Pin 3	Motor 1	Pin 6	FT400 GND Out	Pin 3	PEDAL 1	Pin 6	PEDAL 2

### Australian Chevrolet Omega – 12595829 – GY23 – 08295A FT400 number: 04B089066102012201401A1

Throttle – General Motors Corp.				Pedal			
Pin A	Motor 1	Pin D	TPS 1	Pin 1		Pin 4	
Pin B	Motor 2	Pin E	FT400 GND Out	Pin 2		Pin 5	
Pin C	FT400 5V Out	Pin F	TPS 2	Pin 3		Pin 6	

### Chevrolet Corvette V8 – STOCK CAR – 233905109 – 0484A – 0531A FT400 number: 04D08806D102112201401AA

Throttle – General Motors Corp.				Pedal			
Pin A	Motor 1	Pin D	TPS 2	Pin 1		Pin 4	
Pin B	Motor 2	Pin E	FT400 5V Out	Pin 2		Pin 5	
Pin C	FT400 GND Out	Pin F	TPS 1	Pin 3		Pin 6	

### BMW 120 and 320 (2007 to 2009) – 1354-7561066-01 FT400 number: 046067076102A1220140194

Throttle –Siemens VDO				Pedal – Hella			
Pin 1	TPS 1	Pin 4	TPS 2	Pin 1	FT400 GND Out	Pin 4	PEDAL 1
Pin 2	FT400 5V Out	Pin 5	Motor 2	Pin 2	FT400 GND Out	Pin 5	FT400 5V Out
Pin 3	Motor 1	Pin 6	FT400 GND Out	Pin 3	FT400 5V Out	Pin 6	PEDAL 2

**Fiat Doblò, Idea, Palio, Stilo 1.8 – Chevrolet Corsa, Meriva, Montana 1.4 and 1.8 Flex 2006 onwards****Throttle** 93397828 **FT400 number:** 03003C05F10101220140122**Throttle** 94705388 **FT400 number:** 04607F06210291220140197

Throttle – Delphi				Pedal – Bosch				Pedal – Hella			
<b>A</b>	FT400 5V Out	<b>D</b>	FT400 GND Out	<b>1</b>	5V	<b>4</b>	PEDAL 1	<b>1</b>	FT400 5V Out	<b>4</b>	FT400 GND Out
<b>B</b>	TPS 2	<b>E</b>	Motor 2	<b>2</b>	5V	<b>5</b>	Terra ETC	<b>2</b>	FT400 5V Out	<b>5</b>	FT400 GND Out
<b>C</b>	TPS 1	<b>H</b>	Motor 1	<b>3</b>	Terra ETC	<b>6</b>	PEDAL 2	<b>3</b>	PEDAL 1	<b>6</b>	PEDAL 2

**Fiat Idea, Palio, Punto, Siena, Strada 1.4 Flex – Motor Fire 1.0 8V****Throttle** 36SMF7 **FT400 number:** 03002B0841003172E14013C**Throttle** 44SMF8 **FT400 number:** 03503807B10081220140137

Throttle – Marelli				Pedal – Bosch			
<b>Pin 1</b>	TPS 2	<b>Pin 4</b>	TPS 1	<b>Pin 1</b>	FT400 5V Out	<b>Pin 4</b>	PEDAL 1
<b>Pin 2</b>	FT400 GND Out	<b>Pin 5</b>	Motor 1	<b>Pin 2</b>	FT400 5V Out	<b>Pin 5</b>	FT400 GND Out
<b>Pin 3</b>	Motor 2	<b>Pin 6</b>	FT400 5V Out	<b>Pin 3</b>	FT400 GND Out	<b>Pin 6</b>	PEDAL 2

**Fiat Punto 1.4 T-Jet – 0280750137 FT400 number:** 0580600CD101512201401E1

Throttle – Bosch				Pedal – Bitrun			
<b>Pin 1</b>	Motor 1	<b>Pin 4</b>	Motor 2	<b>Pin 1</b>	FT400 5V Out	<b>Pin 4</b>	FT400 GND Out
<b>Pin 2</b>	FT400 GND Out	<b>Pin 5</b>	TPS 2	<b>Pin 2</b>	FT400 5V Out	<b>Pin 5</b>	FT400 GND Out
<b>Pin 3</b>	FT400 5V Out	<b>Pin 6</b>	TPS 1	<b>Pin 3</b>	PEDAL 1	<b>Pin 6</b>	PEDAL 2

**Fiat Marea 2.4 – 0205003052 FT400 number:** 05A0660C9101612201401E6

Throttle – Bosch				Pedal – Bosch			
<b>Pin 1</b>	Motor 1	<b>Pin 4</b>	Motor 2	<b>Pin 1</b>	PEDAL 1	<b>Pin 4</b>	PEDAL 2
<b>Pin 2</b>	FT400 5V Out	<b>Pin 5</b>	TPS1	<b>Pin 2</b>	FT400 5V Out	<b>Pin 5</b>	FT400 5V Out
<b>Pin 3</b>	FT400 GND Out	<b>Pin 6</b>	TPS2	<b>Pin 3</b>	FT400 GND Out	<b>Pin 6</b>	FT400 GND Out

**Audi S3 Turbo – 06A133062C – 0280750036 FT400 Number:** 04804B0AC10131220140199**Audi A4, A6, S4, S6 2.4 e 2.8 – 0280750003 – 078133062 FT400 Number:** 05B0DC05F101912201401F6**VW Golf VR6 – 0205003053 - 021133062 FT400 Number:** 04A0510A9100F122014019A**VW Gol G4 1.0 8V Flex - 030133062D – 408238371004 FT400 Number:** 04804B0AC100B1220140191**VW Bora, Polo – 06G133062B FT400 Number:** 0540580CB101812201401D6**VW Golf 1.6, Fox, Gol G5, Polo 1.0 e 1.6, Gol/Parati G3 1.6****Throttle** 036133062P 10DI (408238373R002) **FT400 Number:** 03B03D08E100C1220140159**Throttle** 032133062 10DI **FT400 Number:** 0530600B4101212201401C0

Throttle – Bosch/Siemens VDO				Pedal – Hella			
<b>Pin 1</b>	TPS 1	<b>Pin 4</b>	TPS 2	<b>Pin 1</b>	FT400 5V Out	<b>Pin 4</b>	PEDAL 1
<b>Pin 2</b>	FT400 5V Out	<b>Pin 5</b>	Motor 1	<b>Pin 2</b>	FT400 5V Out	<b>Pin 5</b>	FT400 GND Out
<b>Pin 3</b>	Motor 2	<b>Pin 6</b>	FT400 GND Out	<b>Pin 3</b>	FT400 GND Out	<b>Pin 6</b>	PEDAL 2

**VW Golf R32 – 408238329001 – 022133062 FT400 number:** 05A098086102312201401E2

Throttle –Siemens VDO				Pedal			
<b>Pin 1</b>	TPS 2	<b>Pin 4</b>	TPS 1	<b>Pin 1</b>		<b>Pin 4</b>	
<b>Pin 2</b>	FT400 GND Out	<b>Pin 5</b>	Motor 1	<b>Pin 2</b>		<b>Pin 5</b>	
<b>Pin 3</b>	Motor 2	<b>Pin 6</b>	FT400 5V Out	<b>Pin 3</b>		<b>Pin 6</b>	

**Ford Fusion 2.3L – 6E5G-9F991-A – L3H1 – 093000917 – 4H24 FT400 number:** 02A02706E30111220140118

Throttle –FoMoCo				Pedal – Bosch			
<b>Pin 1</b>	Motor 2	<b>Pin 4</b>	TPS 1	<b>Pin 1</b>	FT400 5V Out	<b>Pin 4</b>	PEDAL 1
<b>Pin 2</b>	Motor 1	<b>Pin 5</b>	FT400 5V Out	<b>Pin 2</b>	FT400 5V Out	<b>Pin 5</b>	FT400 GND Out
<b>Pin 3</b>	FT400 GND Out	<b>Pin 6</b>	TPS 2	<b>Pin 3</b>	FT400 GND Out	<b>Pin 6</b>	PEDAL 2

**Honda Accord** – GMA3A – U10896044142 **FT400 number:** 03603608700091220140142

**Mitsubishi Pajero Full** – 8J06H – 1450A098 **FT400 number:** 04505E07F1022122014018B

Throttle – KeiHin (numbers are on the plug)				Pedal			
Pin 1	Motor 2	Pin 4	TPS 2	Pin 1	PEDAL 2	Pin 4	PEDAL 1
Pin 2	Motor 1	Pin 5	FT400 5V Out	Pin 2	FT400 GND Out	Pin 5	FT400 GND Out
Pin 3	FT400 GND Out	Pin 6	TPS 1	Pin 3	FT400 5V Out	Pin 6	FT400 5V Out

**Mercedes Benz V12** – 1996 to 2001 **FT400 number:** 0460500991014122014018A

Throttle – Mercedes Benz				Pedal – Mercedes Benz			
Pin 1	Motor 2	Pin 5	FT400 5V Out	Pin 1	FT400 5V Out	Pin 4	PEDAL 2
Pin 2	Not Connected	Pin 6	TPS 1	Pin 2	FT400 GND Out	Pin 5	PEDAL 1
Pin 3	Motor 1	Pin 7	TPS 2	Pin 3	FT400 5V Out	Pin 6	FT400 GND Out
Pin 4	Do not connect	Pin 8	FT400 GND Out				

**Nissan 350Z** – SERA576-01 – S 0 6325 0 2 **FT400 number:** 040059075102B1220140180

Throttle – Hitachi				Pedal – Assam			
1	FT400 5V Out	5	TPS 1	1	FT400 GND Out	4	FT400 5V Out
2	TPS 2	6	FT400 GND Out	2	PEDAL 2	5	PEDAL 1
3	Motor 1	7	Motor 2	3	FT400 GND Out	6	FT400 5V Out

**Peugeot/Citroën 1.6 16V todos** – 0280750085 **número FT400:** 0540550CD101712201401D4

Throttle – Bosch				Pedal – Bosch			
Pin 1	Motor 1	Pin 4	TPS 2	Pin 1	PEDAL 1	Pin 3	PEDAL 2
Pin 2	Motor 2	Pin 5	FT400 5V Out	Pin 2	FT400 GND Out	Pin 4	FT400 5V Out
Pin 3	FT400 GND Out	Pin 6	TPS 1				

**Viper V10 8.4L** – 0280750205 **FT400 number:** 04E07F077101E12201401A9

Throttle – Bosch				Pedal			
Pin 1	Motor 2	Pin 4	Motor 1	Pin 1		Pin 4	
Pin 2	FT400 5V Out	Pin 5	TPS 2	Pin 2		Pin 5	
Pin 3	FT400 GND Out	Pin 6	TPS 1	Pin 3		Pin 6	

**Chevrolet Captiva** – 8AA995AA **FT400 number:** 03604406C100E122014013B

Throttle – General Motors Corp			
Pin 1	Motor 1	Pin 4	TPS 1
Pin 2	Motor 2	Pin 5	FT400 GND Out
Pin 3	FT400 5V Out	Pin 6	TPS 2

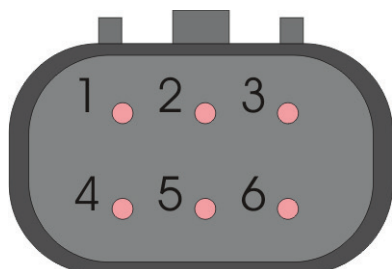

**Toyota Lexus ES430** – 89452-30150 – 3D 17 – 22030-20030 – 3D22 – 00083 **FT400 number:** 04C04A0C5501A12201401BE

Throttle – 2 way connector		Throttle – 4 way connector	
Pin 1	Motor 1	Pin 1	FT400 5V Out
Pin 2	Motor 2	Pin 2	TPS 1
		Pin 3	TPS 2
		Pin 4	FT400 GND Out

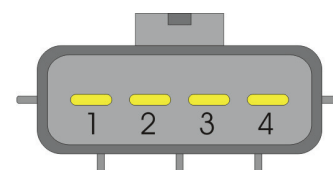
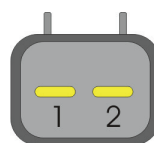

Once the electrical installation of the electronic throttle and pedal is completed, configure the FT400 module according to chapter 17.1 in this manual. This configuration must be done before turning the engine on.

## 11. Using the module

### 11.1 Shortcuts and menu navigation

Navigation through the touch screen is very intuitive and the display facilitates access to information and menus, eliminating the need for buttons. All changes to the module are performed with a light touch to the screen.

Note: in order to access menus, touch the screen twice as in a double click. It facilitates module operation in a moving vehicle and avoids navigation errors.

- 1 - **Dashboard:** Displays information about the engine (RPM, temp., Boost, ignition timing, duty cycle, etc.);
- 2 - **Fuel injection tables adjust:** Access the main fuel injection map, overall fuel trim, engine and air temp compensation, battery voltage compensation;
- 3 - **Ignition tables adjust:** Access the main ignition table, overall ignition trim, engine and air temp. compensation, battery voltage compensation;
- 4 - **Aux functions adjust:** Engine start, rev limiter, decel. cut off, two-step rev limiter, thermaic fan, progressive nitrous, boost control, etc.;
- 5 - **Check control settings:** Access alerts configurations regarding boost and fuel press, RPM, oil pressure, lambda, TPS, etc.;
- 6 - **Interface settings:** Brightness settings, sound settings, protection setup, display calibration, dashboard setup, etc.;
- 7 - **Settings manager:** Menu used to select active settings and to generate a FuelTech standard settings;
- 8 - **Sensors and calibrations:** Provides access to configurations of sensors inputs and to the ignition calibrations;
- 9 - **Input and output setup:** Configuration of auxiliary outputs operation and electronic throttle boby setup;
- 10- **Ignition setup:** Configuration of the ignition control mode (trigger wheel, distributor, sequential or wasted spark ignition,

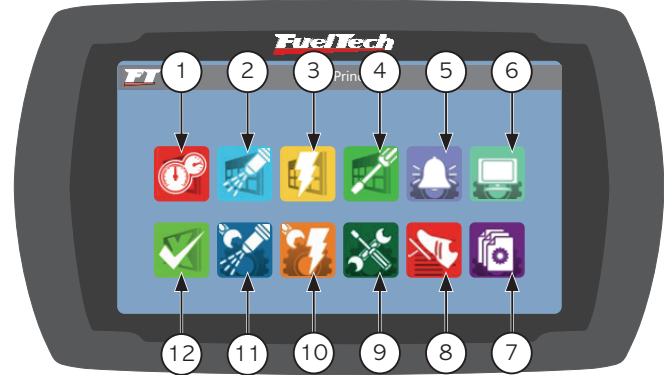

etc.;

- 11- **Fuel injection setup:** Configuration of the fuel injection control mode (one or two banks maximum RPM, etc.);
- 12- **Diagnostic panel:** Allows the verification of all inputs and outputs module. Very useful to check and analyze general operation;

When entering a map or configuration, the user will find:

When the fuel injection and ignition tables are being tuned and the engine is running, a highlighted area in yellow indicates in which location of the selected map the engine is working at the moment. This function is available with all maps - RPM, pressure, temperature, TPS, etc.

- 13- **Highlighted area in red:** Location in the map selected to be edited;
- 14- **Highlighted area in yellow:** (show only when the engine is on) shows the range in which the engine is currently working in real-time;
- 15- **Button -:** Decreases the value of selected parameter;
- 16- **Button +:** Increases the value of selected parameter;
- 17- **Button >:** Moves forward to the next location on the map;
- 18- **Save button:** Saves the changes made to the map or configuration and returns to the main menu;
- 19- **Return button:** Returns to the previous screen. If any map or configuration has been changed, it requests confirmation;
- 20- **Cancel button:** Cancels any changes made to the map and returns to the main menu;
- 21- **Button <:** Returns to the previous location on the map;

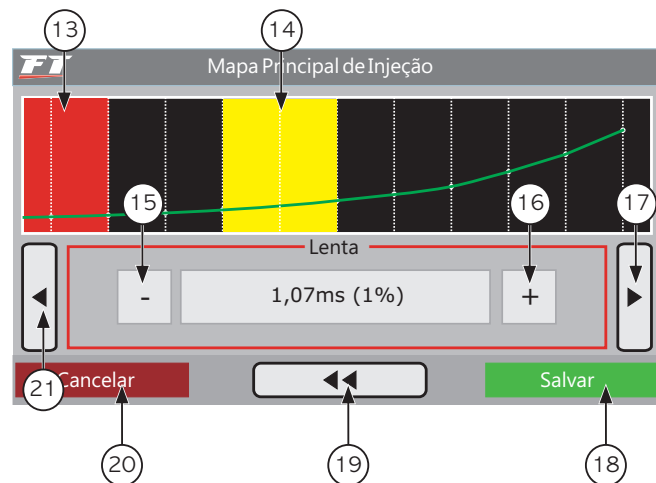



### 1 1.2 Dashboard screen

When the engine is working, the instrument panel shows seven instruments with real-time information. For more information on how to change the gauges on the dashboard, see chapter 19.5.

In order to access the Instrument Panel, touch the icon located at the main menu.

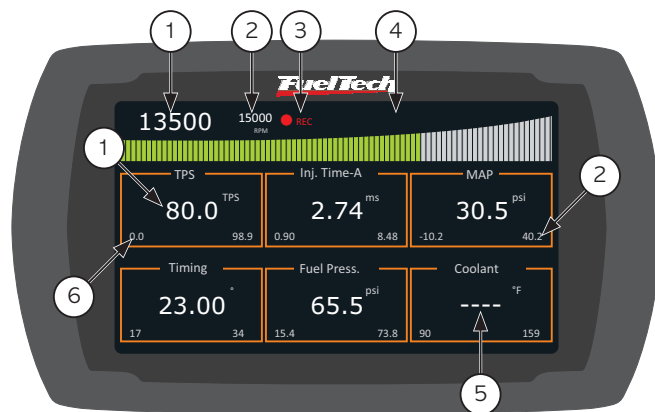

- 1 - Current value in real-time.
- 2 - Maximum value saved.
- 3 - Status internal datalogger.
- 4 - Touch the white area to access the main menu.
- 5 - Disconnected sensor.
- 6 - Minimum saved value.

All maximum and minimum values are saved, even if the injection is turned off, and can be erased by accessing the "Interface Configuration" menu and selecting "Format Peaks".

Minimum and maximum values reached are displayed on the bottom of each frame. Minimum values will be on the left and maximum values, on the right.

### 1 1.3 Diagnostic panel

The Diagnostic Panel is a tool used to detect anomalies on FT400's systems, sensors and actuators. In order to access it, touch its icon at the main menu.



The area in yellow shows the module's controls and parameters in real-time. The area in green allows the user to check which actuators are operational at that moment, which inputs are receiving actuating signal and what is the ETC status.

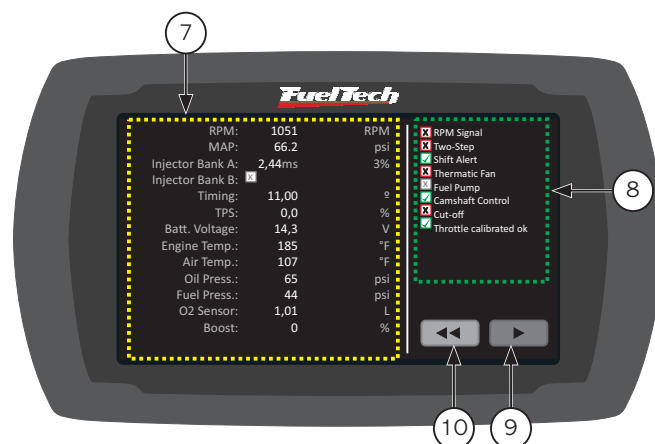

#### Diagnostic panel's legend:

<input checked="" type="checkbox"/>	Input or actuator is activated. For the ETC (FT400 only), it indicates the absence of system anomalies.
<input checked="" type="checkbox"/>	Input or actuator is not activated at the moment. For the ETC (FT400 only), it indicates errors in the system.
<input type="checkbox"/>	Input or actuator is not enabled under Auxiliary Functions menu. For the ETC (FT400 only), it indicates that it is not enabled.

- 7 - Real-time readings.
- 8 - Status of inputs, e outputs and functions.
- 9 - Button to return to the main menu.
- 10- Button to access ETC's diagnostic panel.

#### ETC's diagnostics panel (FT400 only)

When touching the button at the Diagnostics Panel, FT400 displays an exclusive Diagnostics Panel for the ETC. Any anomaly or error detected at the ETC will be shown by this screen.

Below is a list of all anomalies that might occur regarding the installation of the electronic throttle system:

- **Throttle not calibrated:** throttle calibration may only be done after the pedal is calibrated. If the throttle has already been calibrated but it still shows as not calibrated, other anomalies will be displayed.

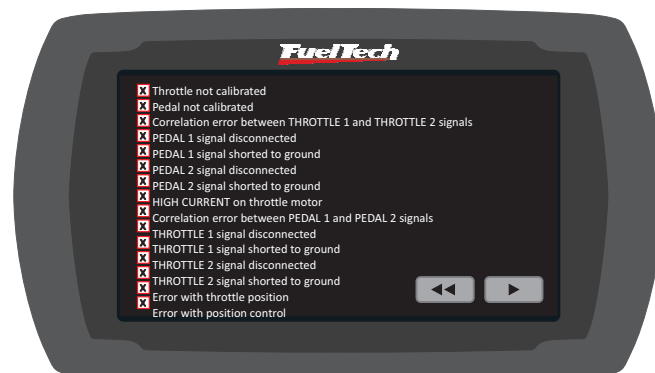

- **Pedal not calibrated:** this message is show when the electronic pedal has not been calibrated through the “Sensors and Calibration” menu yet. Usually, all is needed is to calibrate the pedal according to instructions given in chapter 16.1.1 in this manual.
- **Correlation error between TPS or PEDAL signals:** it indicates that it was not possible to calibrate the pedal or the throttle because of wrong connection or defect.
- **Pedal or Throttle signal disconnected:** the throttle or pedal wire is disconnected.
- **Pedal or Throttle signal shorted to ground:** the throttle or pedal wire is short-circuiting to ground / battery’s negative terminal.
- **High current on throttle motor:** throttle has a problem is soiled or there is an object obstructing its movement.
- **Error with throttle position:** the throttle position is not properly following the pedal. Wrong throttle selected, problem with the throttle’s gears (they may be broken), throttle is soiled.
- **Error with position control:** ETC module is capturing electromagnetic interference for being close to the ignition system or other source of electromagnetic noise, problem with the controller caused by excessive temperature (installation at an inadequate site).

## 12. Configuration and settings – step by step

### 12.1 First step – fuel injection setup

In this menu, data regarding the engine and injection control modes must be informed.

Description of functions in the Fuel Injection Setup menu:

**Maximum RPM:** it is the maximum RPM value to which the fuel injection maps will be limited, i.e., the RPM Compensation Table based on RPM will be created up to the limit value informed in this menu. This parameter is also used for the calculation of the fuel injectors’ opening percentage, shown in the Main Fuel Table.

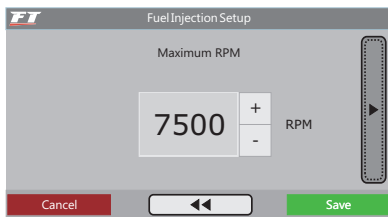

**Piston or rotary engine:** select what kind of engine the ECU will control, if Rotary or piston engine.

**Type of engine and choice of regulation parameter for idle speed:** in this option, the user must select the type of engine (Aspirated or Turbo) and the parameter that will regulate the Idle Speed operation:

**Aspirated by TPS:** this option is usual for aspirated engines without steady vacuum, whether because it has a competition camshaft, body of throttle valves with small restriction, or simply because of user’s choice. The Main Fuel Table will be based on TPS, in which the injection is adjusted at every 10% of opening of the throttle (TPS), from idle speed (TPS 0%) up to full acceleration (WOT – “Wide Open Throttle”, TPS 100%).

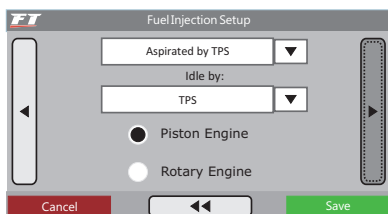

**Aspirated by TPS/MAP:** in this option, the Main Fuel Table will be based on TPS, but there is fuel compensation (in percentage) by MAP, based on the intake manifold vacuum or on the atmospheric pressure only.

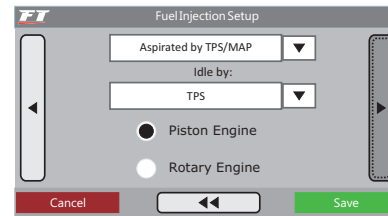

**Aspirated by MAP:** this configuration mode is indicated for aspirated engines with steady vacuum, because the readings of the intake manifold vacuum represents the engine charge better than the opening of the throttle, especially in situations when the RPM varies, as the fix opening of the throttle can represent different levels of vacuum in the engine due to differences of flux at the throttle. Cars with competition camshaft in which the Main Fuel Table is done based on MAP, may have unstable vacuum during idle speed; in this case, FuelTech recommends that the “idle speed by TPS” option is chosen, so, when TPS readings are 0%, the fuel injection will start considering the idle speed value from the Main Fuel Table, disregarding the MAP readings.

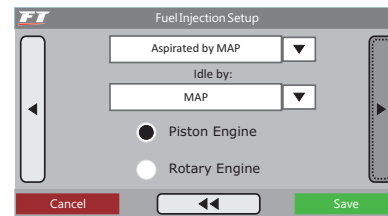

**Turbo by MAP:** in this configuration, the Main Fuel Table is a Fuel Injection x Pressure Map, beginning at -13psi up to the maximum pressure configured (up to 87psi of boost pressure, which means 101psi of absolute pressure). In turbo cars with competition camshaft, one can choose the “idle speed by TPS”, as in the previous option.

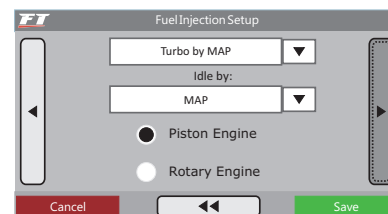

**Maximum boost pressure:** When the car has a turbo or blown engine, this option can be configured so the Main Fuel Table is limited above pressures that will not be used. For example, in a car that will use the maximum boost pressure of 29psi, a value of 36psi can be chosen as the maximum pressure (a margin is given for regulation purposes), therefore, the Main Fuel Table will range between -13psi and 36psi, and for anything above this, the last value in the map will be considered. This parameter does not limit the pressure generated by the turbine, only the maximum value from the Main Fuel Table.

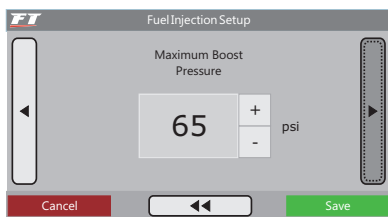

**Acceleration enrichment:** the acceleration enrichment is the increase in the amount of fuel injected when there is a quick variation of air flux in the engine. This alteration can be compensated by the injection through variation in the throttle (TPS) or in readings of vacuum/pressure in the manifold. As the throttle variation is what generates pressure alterations, the Quick Fuel Injection based on TPS tends to be more effective.

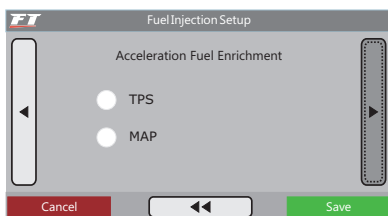

**Fuel injector banks:**

- **One bank:** the driving of the two injection outputs will happen at the same time, i.e., all injectors connected to the fuel injection system will pulsate together, at once. Then, one bank of injectors can be used to feed the whole engine, from aspirated phase up to turbo maximum pressure.
- **Two banks:** the control of the two injection outputs is separate, i.e., each output will have a different behavior, according to what has been programmed in the system. In aspirated engines, the second bank can be used to add to or to substitute the first bank of injectors (one bank next to the cylinder head and the other above the throttle valves, for example). In turbo engines, one bank of injectors is used to feed the engine's aspirated phase, and the other bank is used to feed the positive pressure phase.

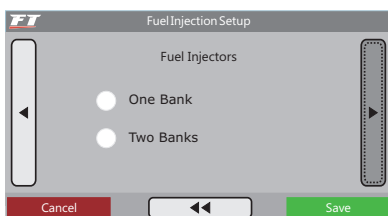

**Number of cylinders:** the user must inform the number of cylinders in the engine.

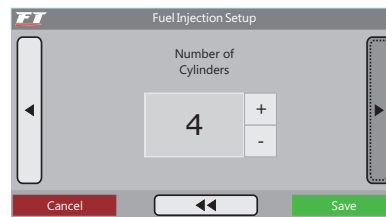

**Injection mode (only shown when ignition by distributor is checked):** this parameter determines how the driving of injectors occurs.

- **Normal:** the injection pulses happen along with the ones from ignition; therefore, there is an injection pulse to each ignition pulse. This mode is used when the injectors are installed near the Throttle Body Injection (TBI).
- **Alternated (recommended):** in this mode, the module will release an injection pulse to every two ignition pulses. This mode must be selected when the injectors are installed near the intake valve (what is usually the standard for cars that were originally manufactured with electronic injection).
- **Wasted Spark:** this option is used when RPM signal is captured directly from the negative terminal of a coil working on Wasted Spark System in 4-cylinder cars, called Double Ignition Coil. The signal must be captured in this way especially in cases when the ignition system does not feature a normal RPM output. It is only used when the ignition has been disabled. The RPM is doubled as only half of it is captured.
- **Synchronized:** using this configuration, the fuel injection is synchronized with the engine RPM; therefore, there is one injection pulse for each engine RPM, except when there is an odd number of cylinders. This mode is very much used when the fuel injectors have a high flow rate. Only available on engines with 6 cylinders or more.

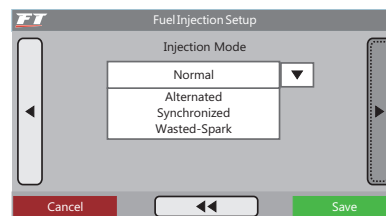

**Injectors deadtime:** all fuel injectors, for they are electromechanical valves, have an opening inertia, which means that there is a "dead time", a moment in which the injector has already received an opening signal, but still has not started to inject fuel. This parameter considers, as a standard value, 1.00ms for high impedance fuel injectors, which is taken into account for the calculation of the injection percentage, especially for compensations or quick adjustments.

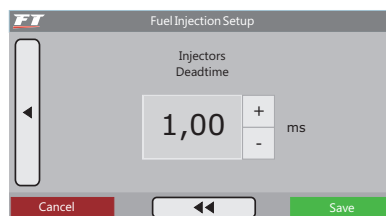

## 1.2.2 Second step – ignition setup

The “Ignition Setup” menu must be set to inform how the ignition will be controlled. The “disabled” option inactivates the ignition control, which means that only the injection control will be activated. The “Main Ignition Table” menu stays inactive.

### Ignition with distributor

This configuration indicates that the spark distribution will be done by a distributor, and that the engine will only have one ignition coil, despite the number of cylinders. In this case, only the ignition output “A” will send pulses to the coil, the others will be disabled.

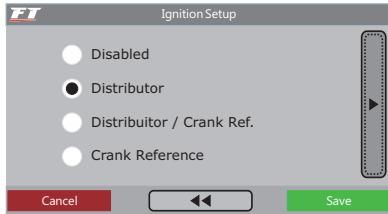

**RPM sensor angle:** it is the distributor’s window angle. The standard used is 72° for VW Mi distributors with a larger window and 60° for distributors from GM 4-cylinders and older models of the VW Gol GTi. In the event of a different distributor, this parameter can be altered. For example, in GM V6 Vortec engines (S10 and Blazer), the standard window is 63°. To find out the distributor angle, see chapter 5.5.1 in this manual for instructions.

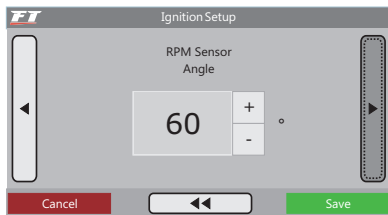

**Ignition output:** Select the ignition type to be used:

- **SparkPRO/Falling edge:** for modern inductive ignition modules, such as the 3-wire Bosch coil, SparkPRO-1, coils with integrated ignition module and Bosch 7-pin ignition module.
- **MSD/Rising edge/duty:** it is used for capacitive discharge ignitions type MSD 6A, 6AL, 7AL2, Crane, Mallory and similar others. Uses fixed duty.
- **Rising edge/dwell:** also called Rising Dwell. Used for Hondas with internal igniter coil on distributor.

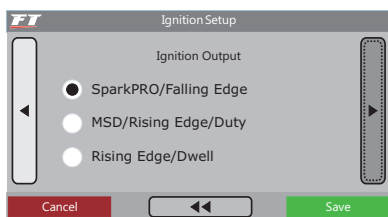

**Ignition dwell:** it is the coil’s charge time, measured in milliseconds. This setting is very important, as each power module and ignition coil has a specific dwell, which, if not regarded properly, can make the ignition become inefficient when using a low dwell, by lowering the spark energy, or, otherwise, can certainly damage the ignition system and/or the ignition coil, when using an excessive charge time.

An adequate charge time for most regular coils and ignitions is between 3.00ms and 3.60ms.

If this time is unknown, begin with a lower value (around 2.00ms) and increase it little by little while watching the temperature from the ignition power module. Diligence is very important because when time is exceeded, the module heats up rapidly and may be damaged in seconds.

Avoid cranking the engine for a long time. In such situations, the module automatically increases the coil’s charge time, which may end up damaging the ignition module.



**Ignition output voltage:** select the ignition coil’s switching voltage. Most coils are switched with 12V. See the table in chapter 7.2 and check if there is any specific note about the type of coil being used.

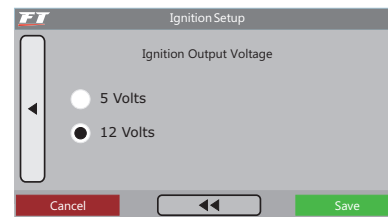

### Ignition with crankshaft trigger wheel

The selection of the Ignition with Crankshaft Trigger Wheel option (Crank Reference) means that the ignition will be controlled without a distributor. In this case, double or individual ignition coils must be used.

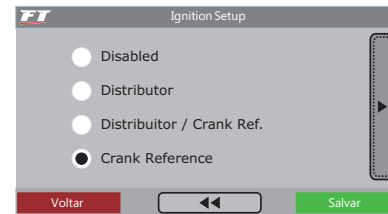

**Crank trigger wheel:** in this option, the standard type of the trigger wheel used in the engine must be informed.

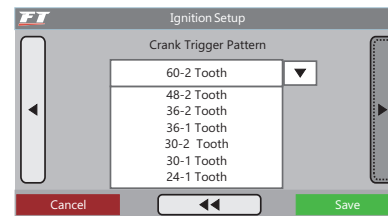

**Crankshaft reference sensor type:** inform if the crankshaft reference sensor type is magnetic or Hall.

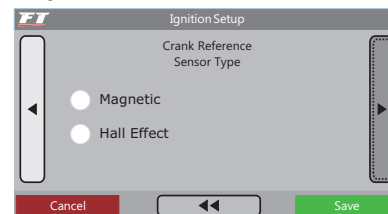

**Crank ref edge:** this option alters the manner in which the module will read the RPM signal. As there is no ideal option for this reading, select Rising Edge. If the module does not capture the RPM signal, change this parameter to Falling Edge.



**Crank index position:** configure the alignment of the trigger wheel used in the engine, informing in which tooth the sensor is positioned when the engine is on TDC (cylinder 1 on TDC). The teeth are counted from the fault reference point (open space with no teeth), counter wise to the engine RPM.

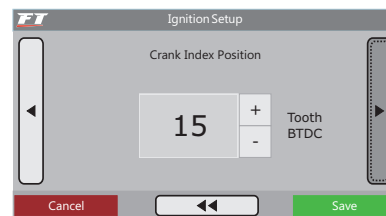

Below is a table with known alignment values and configurations for most of the cases:

Crank trigger - pattern	Engine/brand	Recommended index position	Cam sync sensor
60-2	BMW, Fiat, Ford (inj. Marelli), Renault, VW, GM	123° (GM) 90° (others)	Not mandatory
48-2			Not mandatory
36-1	Ford (ECU FIC)	90°	Not mandatory
36-2-2-2	Subaru	55°	Not mandatory
36-2	Toyota	102°	Not mandatory
30-1			Not mandatory
30-2			Not mandatory
24-1	Hayabusa	110°	Not mandatory
24-2	Suzuki Srad 1000		Not mandatory
24 (crank) or 48 (cam)		60°	Falling edge
15-2	bikes Honda CB300R		Not mandatory
12+1	Honda Civic Si	210° or 330°	Not mandatory
12-1	bikes Honda/Suzuki/Yamaha		Not mandatory
12-2			Not mandatory
12 (crank) or 24 (cam)	Motorcycles/AEM EPM/ distributors Honda 92/95-96/00		Falling edge
8 (crank) or 16 (cam)			Falling edge
4+1 (cam)			Not mandatory
4 (crank) or 8 (cam)	8 cylinders	70°	Falling edge
3 (crank) or 6 (cam)	6 cylinders	60°	Falling edge
2 (vira) or 4 (cam)	4 cylinders	90°	Falling edge



**WARNING:**

Values on the Ignition Calibration table are the commonly used, they may not be correct for all motors. ALWAYS calibrate the timing with a timing light, following chapter 17.2 If the ignition is not correctly calibrated, timing will be incorrect and damage the engine.

**Camshaft position sensor:** in this parameter, the user must inform if the camshaft position sensor will be used and its type (Hall or inductive). The camshaft position sensor is necessary to control the ignition in a sequential mode; when not used, the ignition will always work based on a Wasted Spark system.

**Camshaft sync polarity:** this configuration informs what edge to use to sync: rising or falling edge when the tooth passes by the sensor.

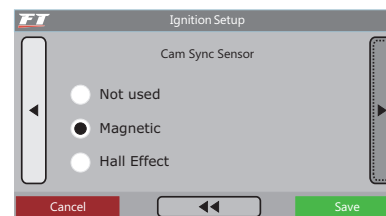

**Ignition mode:** when the camshaft position sensor is used, two options can be selected in this parameter. In “Sequential”, the individual coils will be switched in a sequential mode. In “Wasted Spark”, the ignition coils will work two-by-two.

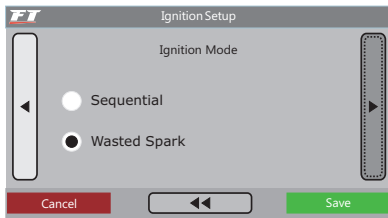

**Ignition output:** Select the ignition type to be used:

- **SparkPRO/Falling edge:** for modern inductive ignition modules, such as the 3-wire Bosch coil, SparkPRO-1, coils with integrated ignition module and Bosch 7-pin ignition module.
- **MSD/Rising edge/duty:** it is used for capacitive discharge ignitions type MSD 6A, 6AL, 7AL2, Crane, Mallory and similar others. Uses fixed duty.
- **Rising edge/dwell:** also called Rising Dwell. Used for Hondas with internal igniter coil on distributor.



**Ignition dwell:** it is the coil's charge time, measured in milliseconds. This setting is very important, as each power module and ignition coil has a specific dwell, which, if not regarded properly, can make the ignition become inefficient when using a low dwell, by lowering the spark energy, or, otherwise, can certainly damage the ignition system and/or the ignition coil, when using an excessive charge time.

An adequate charge time for most regular coils and ignitions is between 3.00ms and 3.60ms.

If this time is unknown, begin with a lower value (around 2.00ms) and increase it little by little while watching the temperature from the ignition power module. Diligence is very important because when time is exceeded, the module heats up rapidly and may be damaged in seconds.

Avoid cranking the engine for a long time. In such situations, the injection automatically increases the coil's charge time, which may end up damaging the ignition module.

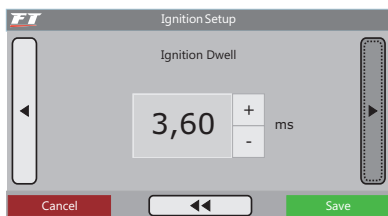

**Ignition output voltage:** select the ignition coil's switching voltage. Most coils are switched with 12V. See the table in chapter 7.2 and check if there is any specific note about the type of coil being used.

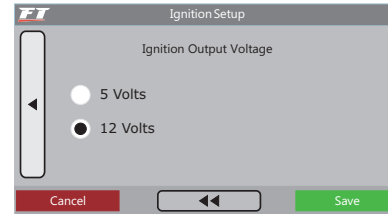

### Ignition with distributor and crankshaft trigger wheel

When the ignition is configured as Distributor/Crank Reference, there is a trigger wheel supplying the engine position information, but the spark distribution will be done by a distributor and only one coil. When using this configuration, **only the ignition output “A”** is active and it will send pulses to the coil, while the other outputs will be disabled.

This configuration is similar to the one in the previous chapter regarding to “Ignition with Crankshaft Trigger Wheel”, but, in this case, ignition happens in a sequential mode. The camshaft position sensor is not used.

### 12.3 Third step – generate FuelTech defaults

When the menus “Fuel Injection Setup” and “Ignition Setup” are properly adjusted, it is possible to create a “FuelTech Default”, a set of basic injection and ignition maps that will serve as the basis for the operation of most engines. After this step is completed, a fine tune on the maps must be done.

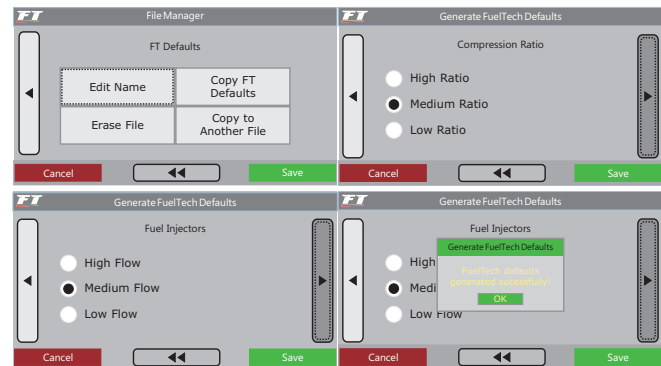

When generating a default map, some information is necessary:

**Compression ratio:** With this parameter, FuelTech Defaults timing tables will be more adequate to the engine.

**Bank A fuel injectors or fuel injectors:** the flow rate of the fuel injector bank that work since idle speed must be informed.

**Initial pressure of bank B:** if the injection mode selected is “One Bank” and the Main Fuel Table is “Aspirated by MAP” or “Turbo by MAP”, the Initial Pressure of Bank B will be requested. This parameter is relative to the pressure in which the Bank B starts to be activated, usually in the turbo phase.

**Camshaft:** the characteristics of the camshaft installed in the engine must be informed. When selecting high profile camshaft, all injection tables from absolute vacuum until -4,3psi are equal, as this type of camshaft does not have steady vacuum at idle speed. When selecting low profile



camshaft, the injection times at vacuum phase are filled up in a linear manner.

The injection module will display a warning to inform that the current configuration will be erased. The user must confirm in order to create the "FuelTech Default". All values in the injection and ignition tables will be overwritten.

**Note:** The parameters to configure Fuel Injectors and Camshaft will only be displayed if the option "Aspirated by MAP" or "Turbo by MAP" has been selected. If the injection map has been set by TPS, information for these parameters will not be requested. When banks of injectors is setup as "Both banks as primary", there will be an option to select when Bank B must start injecting.

"FuelTech Default" is an automatic calculation of the basic injection and ignition tables for the engine, based on the information inserted in the "Fuel Injection Setup" and "Ignition Setup" menus. When going through this automatic adjustment, all the injection and ignition tables (including compensations based on temperature, etc.) will be filled out based on the informed characteristics of your engine.

Therefore, the information inserted in the Injection and Ignition Setup menus must be correct and coherent, the maximum values of RPM and pressure must be in accordance with the engine capacity, and the fuel injectors must have been properly dimensioned based on the engine estimated power.

The FuelTech Default requires that the fuel pressure is set as a fix differential value starting at 43psi, so that for each 14,5psi of turbo pressure, the fuel pressure increases 14,5psi.

This default map shall be a basic reference for engine tuning only, and the user must be very careful, especially in the beginning, as, even though it is an adjustment that will fit most engines, there is no guarantee that it is proper for every situation. Be very careful when tuning your engine. Never put load in an engine before it is perfectly tuned.

Also, it is very important to use an instrument to analyze the air-fuel mixture, such as a regular O2 sensor or a wide band O2 sensor (recommended), pyrometer and/or an exhaust gas analyzer tool.



#### IMPORTANT NOTE:

*Always start the basic adjustments with a rich map, which means that one should always start tuning the engine injecting more fuel than needed, and with conservative ignition timing. Starting with a lean map and an advanced timing may lead to serious damage to the engine.*

## 12.4 Fourth step – sensors check-up and throttle position sensor (TPS) calibration

With this option it is possible to check the connections of all temperature and pressure sensors used with the fuel injection system. The TPS sensor can also be checked and calibrated through this menu.

### TPS calibration

The TPS sensor installed with the injection must be calibrated in the first time the injection is operated, and calibration only needs to be redone if the sensor is exchanged or if its course has been dislocated. This calibration is not erased when the car battery or the injection module are disconnected. For Electronic Throttle – ETC, see chapter 17 in this manual.

#### To calibrate the TPS:

1. Enter the TPS calibration function. The display will show either "TPS: Press ( ) to Calibrate" or "TPS: Calibrated".
2. When pressing the right button, the "TPS Idle Speed" position will be requested. Leave the throttle pedal at rest and confirm.
3. Then, "TPS Full Throttle" will be displayed. Press the throttle all the way and confirm with the right button.
4. The message "Calibrated!" will be displayed if the process was successfully finished.
5. If an error message is shown, check the TPS wiring connections, as well as its connector.

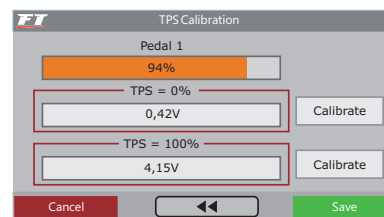

The errors on TPS calibration can be:

**Inverted and calibrated:** it informs that the TPS has been connected in an inverted manner, but it has been successfully calibrated. It would be ideal to check its connection, but it will work anyway if kept as it is.

**Possibly disconnected:** check TPS connections. If it is correct, it is possible that the TPS wiring order is incorrect.

### O2 sensor input

FT400 features and input for the O2 sensor, which can be configured for wideband or narrowband O2 sensors. Make sure to have connected the sensor to the FT400 module as instructed in chapter 5.7 in this manual.

In the case of a wideband sensor, it is possible to choose to have the readings shown on the Instrument Panel as lambda or AFR Gasoline. When using a wideband sensor, the reading is performed by an external conditioner (FuelTech WB-O2 Slim or FuelTech WB-O2 Datalogger) and, therefore, it is necessary to indicate in which scale the equipment's analog

output is working. When using a narrowband sensor, the reading is shown as V.

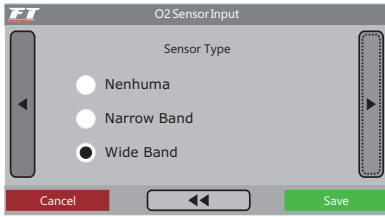

Scale	Output
0,59 – 1,10	$0,59 = 0,2V - 1,10 = 4,8V$
0,65 – 1,30	$0,65 = 0,2V - 1,30 = 4,8V$
0,65 – 4,00	$0,65 = 0,2V - 4,00 = 4,8V$
0,65 – 9,99	$0,65 = 0,2V - 9,99 = 4,8V$

### O2 sensor calibration

Once the O2 sensor is connected and configured, the user must go to the “Calibrate O2 Sensor” menu. If the lambda input has been properly configured, the difference between the readings shown by the external conditioner and the FT will be minimal, inexistent or imperceptible.

In order to calibrate the O2 sensor, do as follows:

1. With the engine turned on, stabilize the value of lambda to 0.90, 1.00, 1.10, etc. and compare the readings from the FT with those from the external conditioner.
2. If the readings from the FT are 1.00 and the ones from the external conditioner are 1.10, it is necessary to decrease the calibration value until the values are equal. Once that is done, compare the readings in other ranges.
3. If the calibration and configuration are correct, there will be no difference in the values of any of the lambda ranges.

4. Calibration values very close to 10000 (maximum value) might indicate an error on the configuration of the O2 sensor input. Usually, the calibration ranges between 0 and 400.

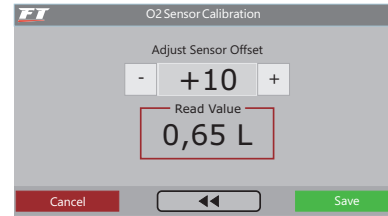

### Intake air and engine temperature input

As the FT is compatible with two types of temperature sensors – engine or intake air -, it is possible to choose the currently used sensor under the “Engine Temperature Input” menu

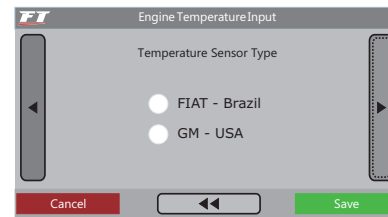

### Fuel and oil pressure input

This menu allows the user to configure the oil or fuel pressure input. The PS-10B sensor features 3 wires and its model and wiring instructions are informed on the decal placed at the body of the sensor.

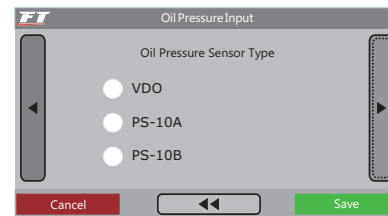

## 13. Starting the engine for the first time

The chapter 11 in this manual provides orientation to the user about all the necessary configurations that must be done prior to starting the engine for the first time. Only proceed in this chapter if you have already read the manual thoroughly up to this point. This will facilitate the understanding of the information in the following chapters.

If there is any difficulty starting the engine for the first time, especially in cars using ethanol or methanol, inject a little gasoline.

If the engine shows that it is difficult to start because of too advanced timing, retard the distributor or change the ignition timing at start (only with trigger wheel). In the case of trigger wheel use, verify if the alignment of the trigger wheel is correct. Also, carefully check if the ignition order is not incorrect because of an inverted ignition cable or coil connection.

When the engine starts, keep it at idle speed and be attentive to the temperature of the ignition coil and the ignition power module. If it heats rapidly, turn off the engine immediately and decrease the ignition

coil's charge time. As a suggestion, the user may want to wait for the temperature to cool down before starting the engine again.

Carefully check if RPM is correctly shown by the injection (with an external tachometer) and if the variations in the throttle match with the value displayed for the TPS and the vacuum readings in the dashboard screen. If strange RPM values are noticed, it certainly means that interferences are occurring when the signal is captured.

### 13.1 Ignition calibration

As soon as the engine starts, before any adjustment, the ignition calibration must be done. This calibration is to make sure that the timing is happening as expected and it is reaching the engine properly. If the distributor position or any

Ignition configuration is not right, the ignition timing will be applied incorrectly. With the use of timing light, it is possible to check the calibration.

The ignition calibration function locks the ignition timing applied to the engine at 20o at any given RPM; therefore, if the engine starts and does not maintain at idle speed, it can be accelerated to any RPM and have the calibration done. The RPM can stay at any value, as long as it is kept with the minimum variation possible, as it may cause errors in the timing light readings.

When RPM is stabilized, enter the "Ignition Calibration" option, in the "Sensors and Calibration" menu.

### Calibration of ignition with distributor

When entering the Ignition Calibration function while using an ignition with distributor, the injection module will display a blinking message that reads: "CALIBRATE DISTRIBUTOR WITH 20o", as shown in the image below.

While this message is being displayed, point the timing light to the mark on the flywheel.

In engines equipped with a distributor there is a TDC on cylinder 1 mark at the flywheel and the engine block. Point the timing light to this mark and turn the distributor until the timing light reads 20o. Fix the distributor, and the calibration is completed.

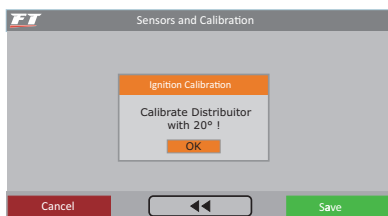

### Calibration of ignition with crankshaft trigger wheel

Cars that are originally equipped with a trigger wheel from the manufacturer don't usually have a mark that indicates the TDC on cylinder 1. To calibrate the ignition, this mark must be done at the flywheel or the engine block.

When entering the Ignition Calibration function, the screen below will be displayed.

This function allows the user to correct the ignition timing directly in the module, as differently from the distributor it is not possible to dislocate the trigger wheel.

If the timing read was 24o, the user only needs to configure a correction of -4o so the timing at the timing light becomes 20o. If it indicates timing with a difference greater than 10o, it is very likely that the alignment of the trigger wheel has been incorrectly informed in the "Ignition Setup" menu.

When the ignition is controlled by a trigger wheel, the ignition system usually works on Wasted Spark, meaning that there are two ignitions per cycle in each cylinder, one at combustion time and another at exhaust time. As the timing light captures both ignitions, it will read the engine timing as 40°. If the timing light does not have a wasted spark mode, the calibration with 40° is correct; otherwise, the correct reading in the engine should be 20°.

In wasted spark, if the timing read in the engine is 46°, for example, the correction applied should be -3°, and not -6°, as its value is doubled.

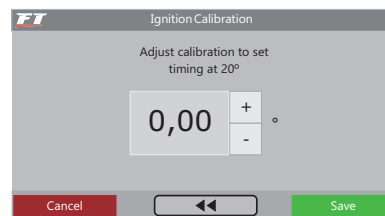

## 14. Fuel injection tables adjust

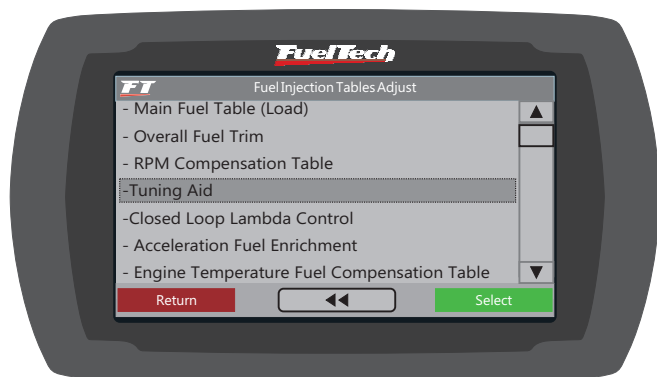

### 14.1 Main fuel table (load)

The amount of fuel injected is measured by the time variation in which the injector is kept open every RPM cycle. At every engine RPM, the fuel injectors open twice, and are kept open for a period of time called "Injection Time", set on the main fuel table. This time is measured in milliseconds (a thousandth of a second; for example, 3.44ms means 0.00344 seconds).

To tune the engine, the injection time values for each interval of engine load are informed (engine load can be represented by the throttle position (TPS) or by the vacuum/pressure in the manifold). Such information is used to constitute the table that will be used as a basis for compensations and, then, determine the exact injection time.

Notice that at intermediate points between the values found on the table, the system runs an interpolation of data. For example, if the map has been adjusted to inject 1.00ms at 10% TPS and 2.00ms at 20% TPS, when the throttle is exactly at 15%, the injection time will be calculated based on the line that connects the 2 points, which is, in this case, 1.50ms, exactly. The interpolation is done with a precision of 0.25% of TPS variation, and 0.01ms of injection time variation.

When the option "Idle Speed by TPS" is selected, it means that when TPS is at 0%, injection time will be determined by the value found in the "Idle Speed" field on the "Main Fuel Table", and all the values for injection time by MAP will be disregarded.

The injection time at Idle Speed will be displayed at first on the Main Fuel Table, as shown in the image below.

The main fuel table can be displayed in 6 different ways, according to the type of engine and the injection mode selected in the "Fuel Injection Setup" menu.

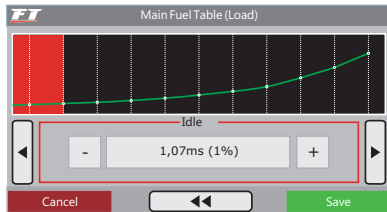

### Aspirated by TPS

This configuration is used to control an aspirated engine that, because of tuning, has high vacuum variations at idle speed and low RPMs. In this setting, the engine vacuum is totally ignored for injection time calculation purposes.

This map represents the amount of fuel that must be injected in each throttle situation. The adjustments in this map can be done with a static TPS in all conditions, varying RPM only, preferably with a dynamometer.

Aspirated engines can use two banks of fuel injectors when one wishes to use fuel injectors with a lower flow rate, having one bank for low charge situations and another bank for when a greater charge is requested from the engine.

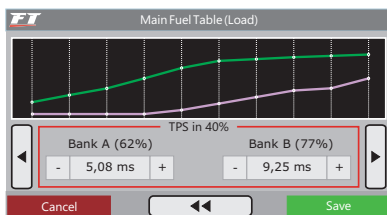

### Aspirated by TPS/MAP

In this configuration, the Main Fuel Table is done by TPS, as in the previous option, but it is possible to apply percentage compensation on injection times according to MAP (engine vacuum). The Main Fuel Table by MAP goes from -13psi to -3psi, with -2psi intervals.

The compensation is very helpful, as the readings of the intake manifold vacuum represents the engine charge better than the opening of the throttle. Especially in situations when the RPM varies, as the fixed opening of the throttle can represent different levels of vacuum in the engine due to differences of flux at the throttle.

### Aspirated by MAP

This configuration is used to control an aspirated engine that has steady vacuum, usually engines with original characteristics or less tuning.

This map represents the amount of fuel that must be injected based on the vacuum readings in the intake manifold. It is the best representation of engine charge, as it is independent from air intake limitations, or variations in RPM and charge situations.

It is possible to individually control the fuel injector banks, according to the vacuum in the manifold in any given situation.

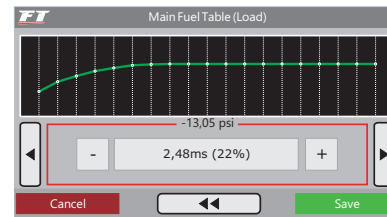

### Turbo by MAP

This configuration is used to control engines that will operate with positive pressure (turbo, blower, etc.). It starts at the injection time of the idle speed vacuum (usually between -12psi and -7psi), and goes up to the maximum turbo pressure used.

This map represents the amount of fuel that must be injected based on the vacuum and pressure readings in the intake manifold.

The intervals between each point on the table are:

- On vacuum ranges: 0,2psi.
- On positive pressure ranges up to 29psi: 0,3psi.
- On ranges above 29psi: 0,5psi.

Turbocharged engines maps usually use two banks of fuel injector, as the Bank A is normally used for idle speed and low charge, being complemented by the second bank when the boost pressure starts rising. It surely allows a better tuning, as it is possible to keep the original injectors on Bank A and use injectors with a higher flow rate on Bank B.

Generally, there is one fuel injector per cylinder on Bank A put next to the cylinder head, and the Bank B has other fuel injectors that will be driven when the first bank comes near its limit.

Bank B may usually be arranged with one fuel injector per cylinder at the intake manifold, or other fuel injectors at pressurization.

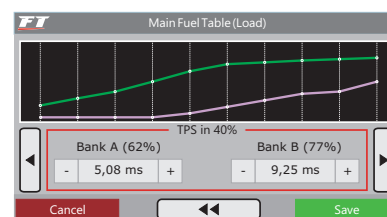

### 14.2 Overall fuel trim

This function recalculates and substitutes all the values in the main fuel table according to the desired setting. It can be accessed through the “Fuel Injection Tables Adjust” menu.

When using two banks of fuel injectors the system will request this overall fuel trim to be done for each one of the fuel injector banks.

Compensation applies a multiplication index to the previous values in the map. For example, if at pressure 1.0bar (for a Turbo by MAP), 2.00ms was being injected, which is equivalent to 50% of fuel injector opening at maximum RPM, and a compensation of +10% is applied, the point on the table will become 2.20ms and 55% of fuel injector opening (and not 60%, as one could mistakenly suppose).

For all compensations applied, fuel injector dead time is considered in order to have a compensation that refers to the real amount of fuel injected, and not the fuel injector opening signal.

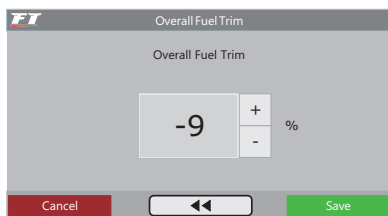

### 14.3 RPM compensation table

The fuel injection map based on RPM is a percentage correction map, which means that these percentages will be applied to the injection times in the main fuel table. The calculation of the injection time is automatically done according to the current engine RPM and to other compensations configured. Therefore, it is not necessary to have a table for each RPM scale, which, although more precise, is time-consuming, and when it is not corrected with a dynamometer, it hardly brings any final improvement.

By using a percentage compensation, it is possible to adjust the injection of any type of engine, be it an original engine, an engine with a more aggressive valve timing control or with variable valve timing control system (such as Honda’s VTEC, Toyota’s VVTi, BMW’s VANOS, etc.).

All engines have its specific consumption peak at the maximum torque RPM. Therefore, it is in this range that a positive compensation of about 5% to 15% must be applied. Such RPM on a regular engine with original valve timing control is usually between 2000rpm and 4500rpm. It is only possible to know the exact RPM with a dynamometer. In real situations, the compensation will be automatically executed by the tuner, as, in order to maintain the lambda at a constant level, the maximum torque RPM will require more fuel.

With the injection map based on charge and this injection map based on RPM, the injection system internally creates a 3-dimensional map of Injection x Charge x RPM, which is automatically applied to the engine.



**IMPORTANT NOTE:**

*Always verify the continuity of the data. Avoid incoherent values or values that will result in graphs with abrupt variations. Any feed, in order to be efficient and correct, must necessarily form graphs with smooth lines.*

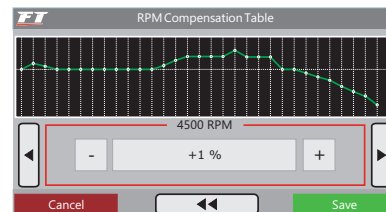

### 14.4 Acceleration fuel enrichment

Acceleration Fuel Enrichment is an increase in the fuel injection when there is a quick throttle variation.

**Maximum fuel pump:** it is the value that will be added to the current injection time when a quick throttle variation occurs.

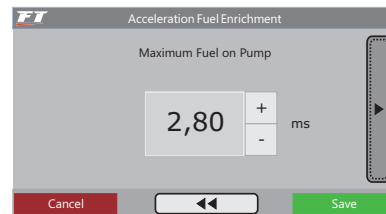

**TPS/MAP variation for max pump:** In this configuration, one must inform the TPS/MAP variation to which the maximum pulse must be applied. Consider, for example, a car running with only 10% of TPS. Suddenly, this value rises to 50%. The TPS/MAP variation was 40%. If the value configured in this parameter is 40%, the maximum pulse will be applied, which means that 4.00ms will be added to the injection time currently applied to the engine. If the variation was only 20% of TPS/MAP, the maximum pulse would not be injected, as it had not reached the value configured in this parameter.

Small throttle bodies usually need a large TPS/MAP variation to inject the acceleration fuel enrichment total pulse (greater values are used, such as 90% of TPS/MAP, for example). On the other hand, when using throttles with a large diameter, a very small TPS/MAP variation is already enough to reach the maximum fuel pump pulse (smaller values are used, such as 15% of TPS/MAP, for example). When a TPS sensor is not used or when maps are configured based on MAP readings, the MAP variation is the one considered for this setting.

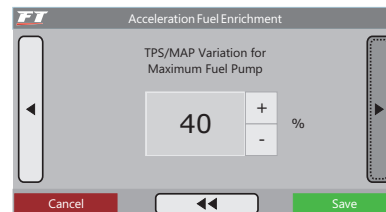

**Maximum RPM pump:** this parameter is used to limit the RPM, above which acceleration fuel enrichment will not be applied.

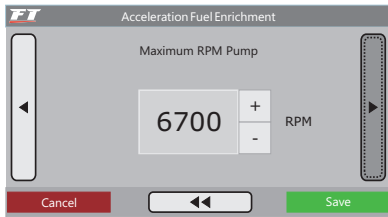

**Cold fuel pump:** increase of acceleration fuel enrichment when the engine is cold, which is extremely necessary in the first minutes of engine operation, especially in engines run with ethanol or methanol.

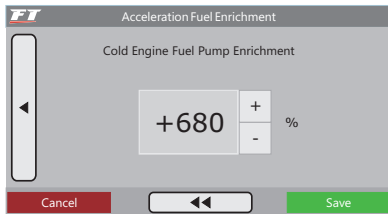

### 14.5 Tuning aid (FT400 only)

The FuelTech Tuning Aid was designed in order to aid the tuner on fuel maps and RPM compensations, according to the chosen lambda values. The whole process is internally executed in FT400 by a high-performance 32 bits processor and it does not require any other equipment but the wideband O2 sensor with a conditioner installed and connected to the FT400.

When opening the FuelTech Tuning Aid menu, the person in charge must understand and accept the fact that this function will make real time changes in the fuel map, which may generate risks if the engine and electronic injection components are not correctly dimensioned and in perfect operating conditions. Fuel injectors with flow rate lower than the one required to feed the engine, O2 sensor reading on FT400 display differing from the external conditioner, air leakage on the exhaust misleading the O2 sensor reading or even a failure in the O2 sensor are all details that will affect the whole adjustment work.

#### Tuning aid characteristics

- It is recommend to wait until the engine reaches between 176 and 194°F and keep it steady during the whole process;
- Tuning Aid only works on bank A;
- The Aid is momentarily disabled when acceleration fuel enrichment occurs (until the O2 sensor stabilizes). Variations/interferences in TPS sensor may activate the acceleration fuel enrichment, requiring the tuner to check the connection of said sensor;

- O2 sensor reaction time after a change in the map may be higher than 2 seconds. This is a characteristic of the engine and it depends on the speed of the exhaust gases and on the oxygen sensor position;
- Function available only for maps configured by MAP (Aspirated by MAP and Turbo by MAP).

#### Configuring the tuning aid

The following are some steps required for the perfect operation of the Tuning Aid:

1. Ensure that the external conditioner display reading is exactly equal to the reading displayed by FT400. More information can be found in chapter 12.4 of this manual;
2. Generate the FuelTech Base Map in FT400 and then use it as basis to start both the manual adjustment and the Tuning Aid. See more information in chapter 11 of this manual;
3. Go to the menu: "Fuel Injection Tables Adjust" and select the option: "Tuning Aid";
4. Read the warning displayed on screen and click "I Agree" if you are aware of the risks involved in the process;
5. The first parameter to be configured is the desired Lambda target on the engine aspirated phase (vacuum).

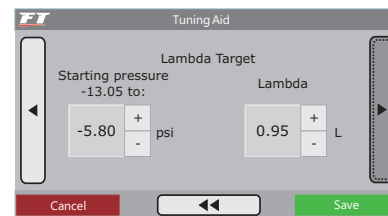

6. Next, it is then configured the Lambda target for 0.00 bar (full load for an aspirated engine).

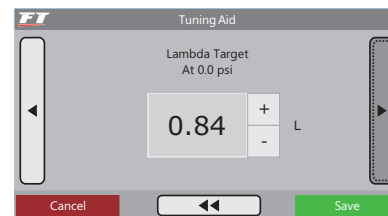

7. The next value to be inserted is the Lambda target for boost phase (displayed only if map is Turbo by MAP). It is only possible to set pressures up to 1.00 bar of boost. For higher boost the Aid is automatically disabled and the ECU works on open loop.



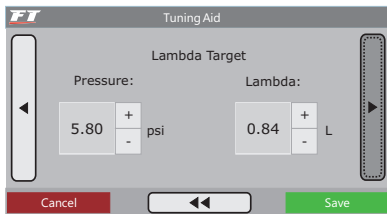

8. In the next screen, there is the Control Speed Gain, which represents the aggressiveness with which the Tuning Aid will perform corrections to the Fuel Map in order to reach the lambda target. For injectors with flow rate way higher than the one required by the engine, this level can be used around 2. In case you utilize high levels in this parameter, the Tuning Aid may become unstable and take some time to reach the programmed lambda target.

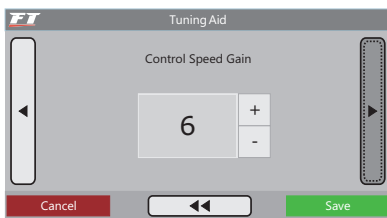

9. In the next parameter it is selected which MAP range will be used to train the RPM map. In turbocharged engines it ranges from -0.2 bar up to the value set. Set it with 0.2 bar above the minimum pressure generated by the wastegate when it has the regulating bolt fully loose. For aspirated engines this option is not displayed but the range goes from -0.2 bar to 0.0 bar. Out of such ranges the RPM map is not modified.

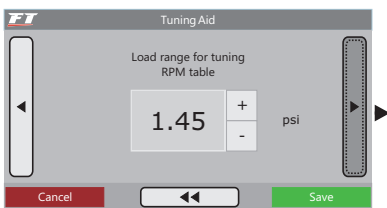

10. The next screen shows any error preventing the Tuning Aid to being the process.

Some of the errors that might occur:

- Engine temperature below 50°C;
- O2 sensor disconnected;
- Injectors working with 100% of their capacity: there is warning whenever any point of the map is with more than 100% of duty cycle (indicating injectors working near their limit). It allows to continue the Aid without problems;

In the event of starting the Tuning Aid with an error being displayed on this screen, it will not operate until the error conditions are corrected.



11. To start click on the button: "Start Tuning Aid process".

Tuning aid screen keys:

**Map ranges in gray background:** indicate points not trained yet. When trained, such points have a black background color;

**Red line:** indicates RPM ranges and MAP where the engine is to be kept so that the Aid can correctly train the map;

**Yellow line:** indicates the range in which the engine is working in real time;

**Yellow rectangle:** displayed when the Aid is changing the map (either of RPM or Fuel map);

**Green rectangle:** indicates the point successfully trained that reached the target lambda; It is possible to interrupt the Tuning Aid at any moment by clicking on the superior parameters, and then, choosing the option below:

**Back:** returns and continues with the Tuning Aid.

**Apply and Exit:** saves the map created by the Tuning Aid, replacing fuel maps.

**Discard and Exit:** cancels the Tuning Aid and returns to the previous fuel maps.

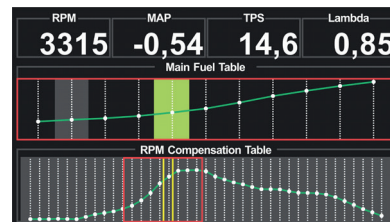

### Tuning aid phases

The Tuning Aid undergoes two phases in order to perform fuel and RPM map adjustment:

#### • MAP range training

1. Start by slowly rolling with the car using a long gear (usually 3rd or 4th);
2. Keep the accelerator stable and the RPM within the red line displayed on the RPM map (2500 to 4000rpm);
3. Wait without changing the TPS until the point being trained changes color, from yellow to green, which indicates that it reached its objective.
4. Go to next MAP point, always keeping the RPM range indicated by the red line.
5. Repeat this procedure in all possible MAP ranges (from -0.7bar until boost);
6. At the time the Tuning Aid identifies that the map was almost fully and correctly trained, it will then suggest to move to the next step and will display a window asking about the action to be taken;
7. If the Tuning Aid does not suggest moving to the next phase, it can be done manually by clicking on the high portion of the screen and selecting the option: "Go to RPM Tuning";

#### • RPM range training

1. In this phase all RPM ranges are released with the purpose of keeping a constant MAP load next to 0 bar,

- i.e., full load in a aspirated engine or low pressure in a turbo engine, safe enough to map all RPM ranges;
- 2. If the engine does not manage to keep a constant pressure, around 0.4 bar, we suggest to skip this phase and tune RPM map manually for safety reasons;
- 3. Considering the aforementioned conditions, start RPM acceleration, as low as possible, up to the maximum desired keeping MAP within the area indicated by the red line and keeping TPS as steady as possible. Remember that when there are TPS variations that trigger a Fuel Enrichment, the Tuning Aid is interrupted.
- 4. Observing the O2 sensor and RPM readings, the RPM curve will be adjusted automatically;
- 5. Repeat the procedure until the desired result is achieved or the Tuning Aid indicates the process success.

**MAP final training**

During RPM map training, the fuel map is still being slightly modified. Therefore, after RPM map trainings, we suggest undergoing again all MAP ranges only for final validation of the generated map.

Once done, the adjustment is nearly completed, the user must now adjust parameters such as acceleration fuel enrichment, engine start, compensation maps per engine and air temperature, as well the whole ignition map. An important detail is that after some significant modification in the ignition map, the Tuning Aid must run again in order to correct changes to the injection map resulting from ignition alterations. Once it is done, it is suggested to activate the Closed Loop function by keeping the same lambda targets.

**Troubleshooting during tuning aid:**

- **Instability when performing corrections:** Control Speed Gain is too high;
- **Lambda target not reached:** may indicate mechanical issues such as low fuel pressure, dirty injectors or with insufficient flow rate to the engine;
- **Difficulty to stabilize or reach target lambda in low loads:** when high flow injectors are used on bank A, they eventually operate with injection time too close to their deadtime (around 1.30 ms), therefore, the Tuning Aid may face difficulties to reach the target lambda. If this happens, we recommend to manually adjusting the low load conditions.

**14.6 Closed loop (FT400 only)**

Basically, the FT400 Closed Loop function has the same lambda target configurations as the Tuning Aid function. The main difference is that the Closed Loop does not change the fuel map; it only works as a temporary compensation to reach the target Lambda set. Also, once activated, it will be permanently running.

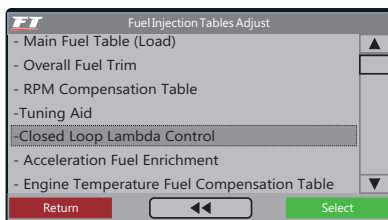

**Closed loop setup**

Once the standard map is generated and the Tuning Aid is used, go to the menu: "Fuel Injection Tables Adjust" and select the option: "Closed Loop". It is critical that the O2 sensor value displayed on external reader and the one displayed on FT are exactly the same, if different; refer to Chapter 12.4 of this manual.

The following are the steps for configuration of Closed Loop:

**Closed loop compensation limits:** Set the maximum percentage of compensation that the closed loop will operate in order to reach the desired lambda target.

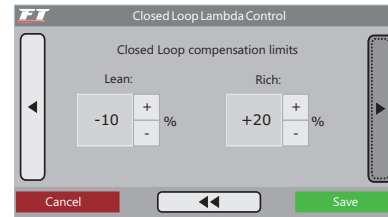

**Closed loop working at:** select the engine operating ranges in which the Closed Loop will operate.

**Lambda target:** the first lambda target will be used for all vacuum ranges from -13.05 psi up to the limit selected (recommended -4.35 psi). From -4.35 psi to 0.0 psi, the lambda value will be interpolated.

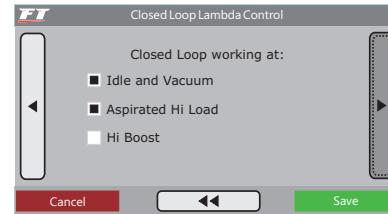

**Lambda target at 0.0 psi:** (atmospheric pressure): lambda target considered for maximum power at the aspirated phase.

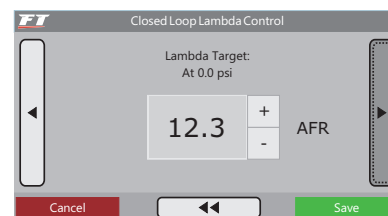

**Lambda target for boost:** (exclusive for Turbo configuration by MAP): target lambda used for positive pressure (above 0.0 psi, up to a maximum of 14.5 psi). For safety reasons, the Closed Loop only controls the engine up to 14.5 psi of boost. Above such values the injection times set in the map will apply, in open loop.

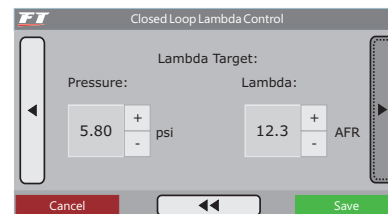

**Control speed gain:** refers to the aggressiveness with which the Closed Loop will operate in the fuel map in order to reach the lambda target.

For injectors with flow rate too higher than the required by the engine, use values next to 2. If using high levels in this parameter, the closed loop may become unstable and take too long to reach the programmed lambda target.

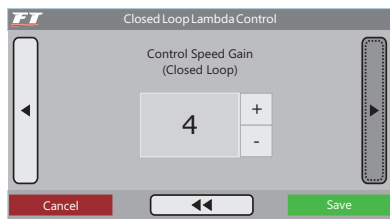

### Compensation map

The closed loop saves a “compensation map” to make the control more effective and faster whenever the engine starts. Upon executing any change in the target lambda or in the map, this function displays on screen an option: “Erase Closed Loop compensations?” it is suggested to click in “Yes”.

### Closed loop at the dashboard

To follow up the operation of this function, go to the menu: “Interface Settings”, “Dashboard Setup” and select the “Closed Loop” displayer. It shows the compensation percentage applied real time in order to reach the programmed target Lambda in the respective menu. In the event of two traces, the closed loop is not working. It happens when the engine is below 50°, turned off or when the two-step button is pressed.

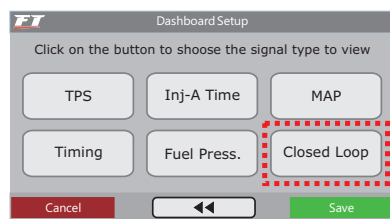

### 14.7 Safety tips during Tuning aid and closed loop (FT400 only)

During adjustment, mainly at the full load range (TPS 100% or boost phase adjustment), some essential tips are to be followed in order to speed up this process and to minimize risks:

- **Abort the run immediately** upon identifying lean lambda in any range. Enrich the map manually in this range. Do not wait for a compensation from the Tuning Aid or Closed Loop in this case;
- If the map is too far from the ideal, it is suggested to follow the traditional procedure out of the Tuning Aid: accelerate the engine to full load and observe the O2 sensor values. Between pulls, make manual compensations until the map is as closest as possible to the ideal
- In turbocharged engines, lower the pressure to a minimum and use a gear in which it is possible to stabilize the pressure;
- Always start the adjustment with an enriched map, the Tuning Aid or Closed Loop will be in charge of removing the exceeding fuel, never expect that they will correct lean lambda critical points;
- If you hear knock noises during adjustment, abort pull and interrupt the Tuning Aid (by clicking on the high portion of the screen), in the event of Closed Loop, go to the configuration menu and disable the function, check the ignition calibration and retard the ignition timing in order to avoid damages to the engine.

As this process requires attention to the guidelines displayed on the FT400 screen, it is recommended to perform such process in a controlled environment such as a dynamometer for safety reasons and better results.

### 14.8 Engine temperature fuel compensation

This compensation is applied based on the engine temperature sensor, which, in water-cooled cars, must be at the cylinder head reading the water temperature, and in air-cooled engines, must be reading the oil temperature. Compensations based on engine temperature are only available when the sensor is connected to the injection system.

Engine temperature greatly influences the amount of fuel requested by the engine, especially in cars run with ethanol and methanol, when it is possible to operate a cold engine as if it had already reached normal temperatures.

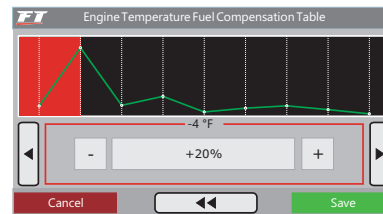

### 14.9 Air temperature fuel compensation

This compensation is applied based on the air temperature sensor placed in the intake manifold, and it is only available when the sensor is connected to the injection system. This compensation mode is used to automatically adapt the injection to different temperatures of the air taken by the engine. In turbocharged engines, it is of great importance, because when the system is pressurized, the temperature rises immediately to very high numbers. In cars with intercooler, the ideal mixture can be used from intercooler inefficiency situations (low speed) on.

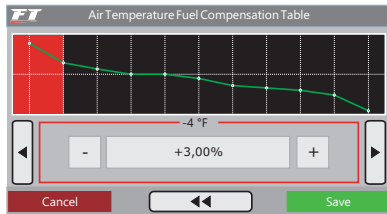

### 14.10 Battery voltage fuel compensation

This compensation is applied based on the vehicle's battery voltage and it takes into consideration that the decrease in fuel injectors' feed voltage influences their opening time. It is a subtle compensation, but very useful in cases when there are great voltage variations caused by the lack of an alternator, for example.

Fuel injectors with a high flow rate usually operate with minimum injection time at idle speed and are the ones most affected by a drop of battery voltage, as a variation in their dead time occurs, which may lead to an injection glitch, meaning that the fuel injectors may not work as a result of voltage drop. By using this compensation, such problem is avoided.

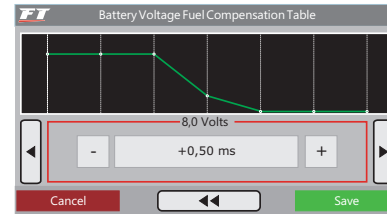

## 15. Ignition tables adjust

It is very important to notice that all maps can advance or retard the timing established in the main fuel table, and that when a "FuelTech Default" is generated, all maps will be filled out with standard values. Therefore, if you wish the ignition timing to be established only by the Main Ignition Table based on RPM, you must manually erase all ignition tables based on Pressure/TPS, Engine Temperature and Air Temperature back to ZERO.

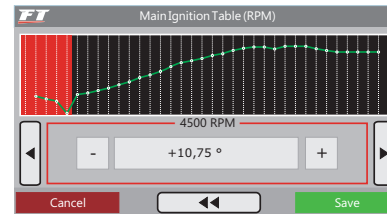
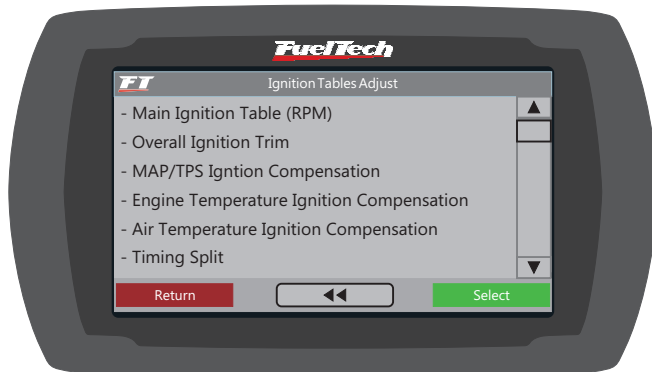

### 15.1 Main ignition table (RPM)

The Main Ignition Table based on RPM is a table in which the main ignition advance curve is indicated by inserting the desired ignition timing at every 200rpm up to the RPM limit.

By analogy, for example, if one wishes to have an initial timing at 15° and a final timing at 32° (as it is done with a distributor), the values inserted in the table must be 15° at 600rpm, 17° at 1000rpm and so on, gradually, until reaching the 32° at, let's consider, 8600rpm, as the final timing point. In a different situation, if one wishes to have constant ignition timing at 24°, for example, all fields in the table must be filled out with 24°.

Notice that for ignition timing to be applied exactly with the values established in the ignition map it is necessary to erase all compensations based on air and engine temperature, pressure, etc. back to zero.

### 15.2 Overall ignition trim

To apply a correction quickly to the entire ignition map, the Overall Ignition Trim function may be used. It is only necessary to inform the correction, negative or positive, and confirm by pressing the right button. This correction will be added to or subtracted from the entire ignition table based on RPM.

This function is very useful in critical situation when one wishes, for example, to quickly retard the ignition timing because of a problem, or when one wishes to be a little bolder about the ignition timing in search for a better performance.

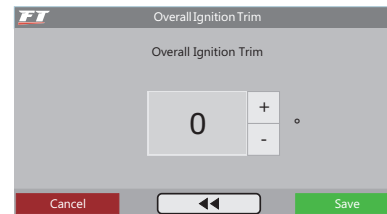

### 15.3 MAP/TPS ignition compensation

A map based only on engine RPM does not provide maximum efficiency in all engine's power ranges. For example, a turbocharged engine requires more retarded ignition timing when working with positive pressure than when working on aspirated phase. Without a retard based on pressure, one would have to keep the entire ignition timing retarded to have a good performance under charge, but in opposite

situations it would lack ignition advance, thus, decreasing torque and power.

When the module is configured to control an aspirated or a turbocharged engine by MAP, the engine charge compensation map is based on pressure, starting from a compensation value at idle speed, up to the maximum turbo pressure.

When the module is configured to control an aspirated engine by TPS, this map is based on throttle position (TPS), as it represents the load that is being requested from the engine, and with that information it is possible to define the points of greater advance and retard in the ignition timing.

### 15.4 Engine temperature compensation

This map represents a timing compensation applied to the main RPM map based on engine temperature variation. It is a very important feature and it brings significant improvement on drivability, especially while operating cold engines, when advanced ignition timing is necessary in order to have a correct response from the engine. It is also essential for engine protection, as it retards the ignition timing when the engine reaches high temperatures

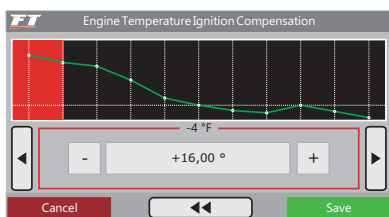

### 15.5 Air temperature compensation

This map represents a timing compensation applied to the main RPM timing map based on intake air temperature variation. It is beneficial,

because the colder the air entering the combustion chamber, the denser it is, and the greater the possible ignition advance is. But when temperatures are very high (especially on turbocharged engines), the ignition timing must be retarded to protect the engine.

It is a very helpful feature, particularly when the engine is exposed to great variations of air temperature caused by weather changes, or variations of intercooler or ice cooler efficiency, for example.

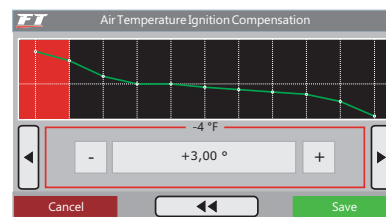

### 15.6 Timing split

This menu is only shown when controlling Rotary engines. This is the timing split between Leading and Trailing spark plugs.

This is a fixed timing split, this means that the trailing spark plug will be fired "x" degrees after the leading spark plug, considering the entire ignition table by rpm. This means the trailing spark will have the same ignition table that the leading spark, but, retarded "x" degrees.

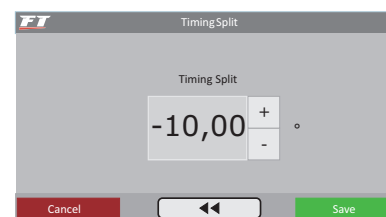

## 16. Auxiliary functions adjust

This menu allows the adjustment of all functions that modify the operation of auxiliary outputs and compensations of engine start, idle speed, etc. Some functions depend on previous configurations of an auxiliary output for its proper operation. The following message will be displayed if the accessed function has not been configured to an auxiliary output yet. For this configuration, enter the "Input and Output Setup" Menu and set up the selected output.

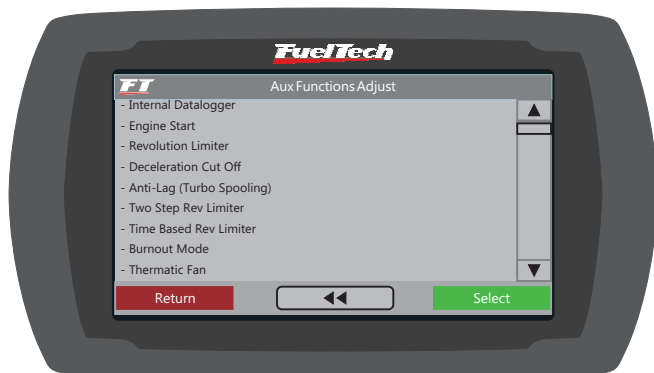

### 16.1 Internal datalogger

This function is used to log all the engine data read by FuelTech ECU. To view the internal log you just need to download the software FuelTech Datalogger ([www.fueltech.com.br](http://www.fueltech.com.br)), and connect the ECU to the computer with the FuelTech USB/CAN Converter.

The Internal Datalogger can record up to 24 channels like: injection time (banks A and B), injectors duty cycle (banks A and B), timing, engine rpm, auxiliary output status, TPS, coolant and air temperature, oil and fuel pressure, O2 sensor, two-step button, MAP sensor, camshaft position sensor and battery voltage.

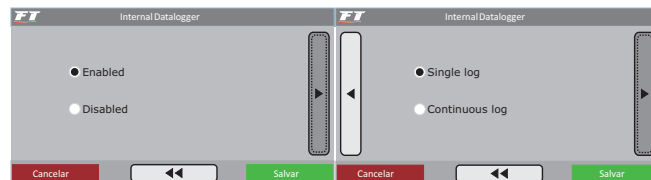

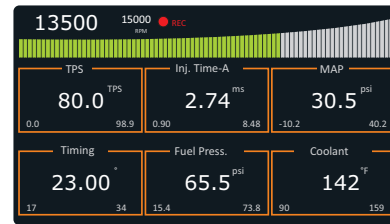
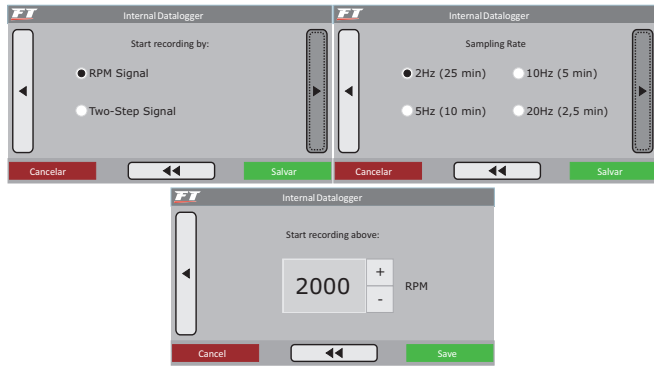

### Recording mode

There's two ways to setup the internal Datalogger: "Single Log" and "Continuous Log".

**Single log:** the ECU logs data until memory is full, after that, data logging is stopped and the log is stored. It is needed to download the log file to a PC using a FuelTech USB/CAN Converter and the FuelTech Datalogger software.

**Continuous log:** in mode the ECU is continuously recording engine data. When memory is full, the log is overwritten. In this manner, you always have the last minutes of engine data recorded on the internal log.

### Log start

There's two ways of starting the log: RPM signal or Two-Step button. When selecting "RPM Signal", the log will start only when the adjusted rpm is reached by the engine. The rpm setup menu will only be shown when selecting this option.

When choosing by "Two-Step Button", the log will start when two-step button is pressed.

The recording can only be stopped when the memory is full (Single Log) or when the ECU is shut off (Continuous Log/Single Log). Remember that if the ECU is turned on again, data will be kept only until a new log is started (programmed rpm reached or two-step button pressed), in this case, previous log will be overwritten.

### Sample rate

The sample rate defines log quality. Higher the sample rate, more detailed is the log, however, the logging time will be short. For competition vehicles, especially drag racing, it is recommended to use a high sample rate to have high detail level on the log.

### Internal datalogger status

At the Dashboard Screen of the ECU, a round icon is shown besides engine RPM. This icon indicates the Internal Datalogger status.

- **Gray icon:** Internal Datalogger **disabled**;
- **Dark red icon:** Awaiting log start;
- **Light red icon (REC blinking besides):** recording log;
- **Dark red icon (FULL written besides):** memory full, data need to be downloaded to a PC in order to continue recording. This icon is only shown in Single Log mode

## 16.2 Engine start

This function is essential when starting the engine, as it needs a greater injection pulse to initiate its operation, especially if the vehicle runs on ethanol or methanol. The amount of fuel necessary to start the engine also depends very much on its temperature, as the colder it is, the more fuel is needed.

When cranking the engine at regular operation temperature, any excess of fuel can make it choke. By using 3 parameters in this function, it is possible to define perfectly the curve of the engine start injection based on engine temperature.

Whenever the RPM drops below 600rpm, the injection applies start injection pulses in addition to the idle speed value. This excess of fuel prevents the engine from failing involuntarily, making it return to idle speed. Be careful not to exaggerate on injection time, as it may cause the engine to choke easily.

The engine must always be turned off through the injection system. Otherwise, if RPM drops below 600rpm and injection is turned on, the system injects fuel that will not be burned and, therefore, will be accumulated on the cylinder. For that reason, it is ideal to install the injection along with the vehicle's start key.

If the engine temperature sensor has not been installed, only the value from start injection with cold engine is considered.

When operating on one bank Injection Mode, both injector outputs injects at the start; but when operating on two banks Injection Mode, only the injectors bank A pulses at the start.

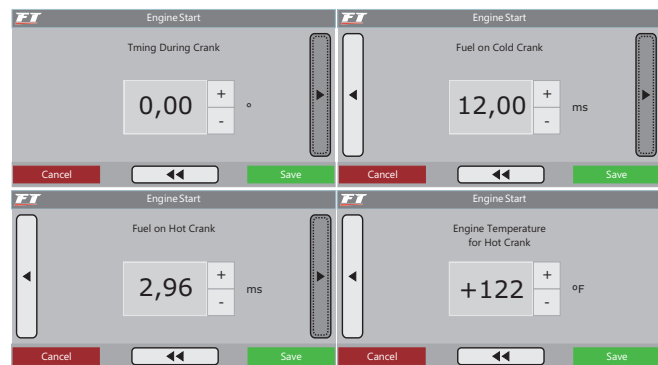

## 16.3 Revolution limiter

This function is very important for engine protection, limiting the RPM with three different options of cut-off:

**Fuel injection:** the fuel injection is cut-off instantly, as the ignition is still operating. It is a very smooth and clean cut-off. Recommended only for low-power engines, it is the standard setting in vehicles with original injection systems.



**Ignition:** the engine ignition is cut-off when the configured RPM is reached. It is recommended for high-power engines, especially turbocharged ones, being the most efficient and safe option.

**Ignition and fuel:** at first, the ignition is cut-off, and after a configurable tolerance of few RPMs, the fuel is also cut-off. When using this option, problems with excess of fuel during the cut-off are avoided, diminishing its damaging effects.

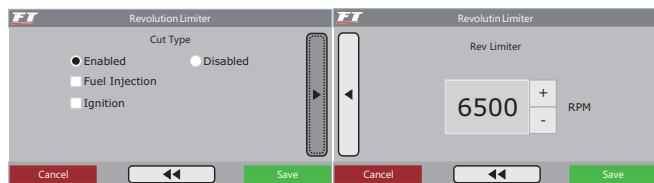

### 16.4 Deceleration cut-off

This function cuts-off fuel every time the throttle is not being pressed and the engine is above the chosen RPM. It results in a great gain of economy, because fuel is not wasted when the car is let run with gears engaged, when engine break is being used, or when the driver steps off the gas to make turns or in regular transit situations. When situations like the ones mentioned above are considered altogether, the deceleration fuel cut-off provides a valuable reduction of fuel consumption after all.

Another benefit in using this function is keeping the engine of a circuit car “dry on fuel” when coming out of turns. When a circuit car has its breaks actuated in order to make a turn, it is necessary that it has a quick and clean response from the engine as soon as it starts picking up speed again at the end of the turn. In long races, the economy is another very important factor.

A standard RPM of 2000rpm is recommended. Setting a very low RPM may cause the engine to turn off involuntarily during deceleration. On the opposite case, when setting a very high RPM, there will not be significant fuel economy.

The “Cut-off Delay for TPS=0%” parameter is the time (in seconds) waited before fuel is actually cut-off after releasing the throttle. Such delay exists to avoid the engine to instantly become lean when the throttle is released. It also rapidly cools the combustion chamber without being excessive, and avoids situations in which the cut-off might oscillate, especially when the throttle is lightly pressed. A standard delay of 0.5s is suggested.

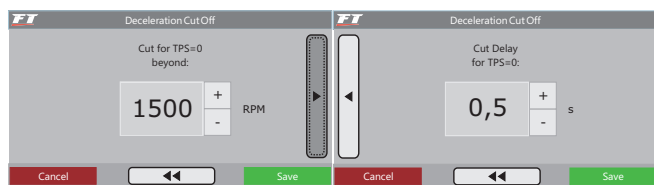

### 16.5 Anti-lag – turbo spooling

The turbine lag is a time delay on the activation of the turbine with maximum efficiency, usually common in engines with turbines dimensioned for great power levels and that take some time to start in low RPMs, when the engine does not have flow and heat enough in the exhaust to reactivate more effectively. The Anti-Lag function is

used to improve the process of filling up the turbo pressure, generating a retard on ignition timing and an enrichment of the mixture above what has been set on the basis map.

Retarding the timing, along with the mixture enrichment, makes the exhaust temperature increase, and, consequently, reducing the turbine lag.

It is important to notice that a high timing retard and a high level of enrichment may result on a much accentuated loss of power, which is the opposite effect of what is expected. It is recommended to use a retard value around -5.00o and enrichment lower than 10%.

The Anti-Lag function is activated when TPS is above 95% and the pressure is within the limits set in the system. In the example above, once the system identifies that TPS is above 95% and the pressure is between 3 and 9psi, the ignition timing is retarded in 5o, and the fuel injection is corrected in 8%.

### 16.6 Two-step rev limiter

The two-step function is activated when its input is connected to the battery’s negative terminal. When pressing the two-step button, usually installed on the steering wheel, the system activates an ignition cut in a programmable RPM (generally between 3000rpm and 6000rpm), with a retarded ignition timing (normally equal or lesser than 0o), and a mixture enrichment given in percentage (also programmable).

When the car is stopped and the two-step is on, it is possible to reactivate the turbine to very high pressure levels, giving the torque needed by the engine and allowing the launch to occur with lower RPMs, and, consequently, having less loss of traction.

It is important to know that this function results in a great increase in exhaust temperature and pressure, generating a very loud noise, and, if used for more than a few seconds (it is recommended that it is used for no more than 8 seconds), it may bring serious damage to the engine, ignition spark plugs, turbine and exhaust.

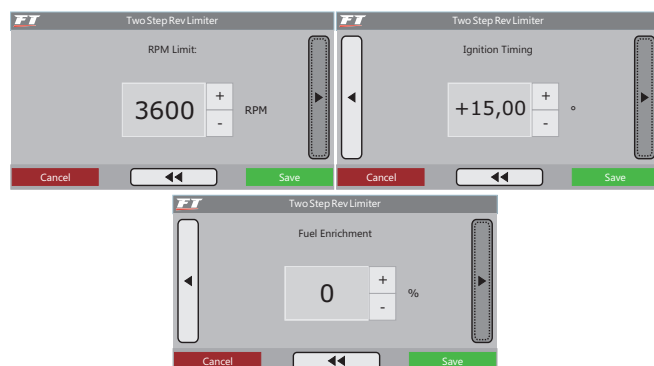

### 16.7 Time based RPM control

The RPM control is based on seven RPM and time points that can be determined as shown in the image above. This function is frequently used in drag racing cars, because it makes it easier to control the vehicle, once it allows the traction to be recovered through an ignition cut ramp. It is a passive traction control, and therefore, some attempts must be made before finding the perfect adjustment, considering the characteristics of the car and the quality of traction provided by the track.



### 16.8 Burnout mode

The Burnout Mode is a function used to facilitate the processes of warming up the tires and using the two-step. When the Burnout Mode is activated, it avoids the RPM Control from being initialized, so its ignition cut configurations are the parameters considered by the system.

This function must be enabled through the "Input and Output Setup" menu. Once enabled, press and hold the up button for 2 seconds on any dashboard screen. The message below will blink to indicate that the Burnout Mode has been activated.

When this message is blinking on the screen, the configuration set for the "burnout limiter" parameter becomes the value considered for the final ignition cut. But when the two-step button is being pressed, the value considered is the one set for the two-step parameter. The values adopted for ignition timing retard and enrichment are the ones configured on the two-step function.

After having warmed up the tires, the user only needs to press the up button for the injection to return to its standard operation mode.

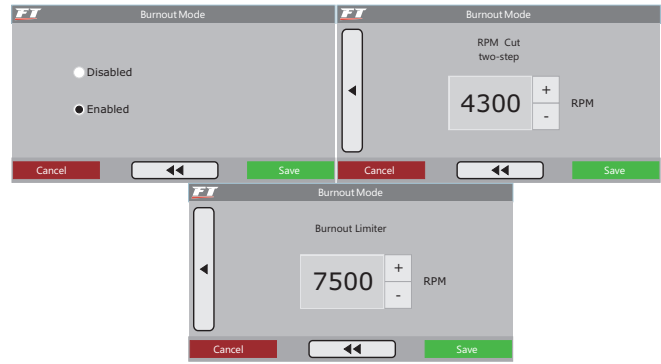

### 16.9 Thematic fan

The electric fan control in the engine cooling system is based on the temperature in which it is expected to be activated and disabled. One can establish that the electric fan must be activated when the engine reaches 194 F and turned off when it cools to 180 F. At the "Input and Output Setup" menu, select the output that will be used for this actuator and, then, inform the chosen temperatures.

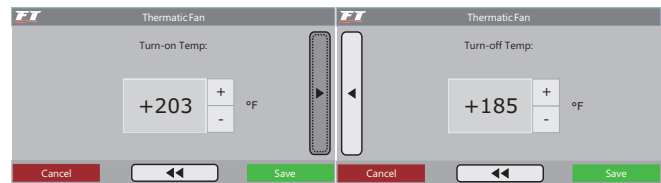

### 16.10 Idle speed control

FT350 can control idle speed only by ignition timing. FT400 can control idle speed through electronic throttle, step motor and by ignition timing. To enable electronic throttle control it necessary first to enable it through "Electronic Throttle" menu under "Input and Output Setup", then, idle speed settings can be done.

#### Idle speed by timing

Idle speed by timing is based on stock ECUs that vary the timing in order to change the engine rpm. A target rpm for idle speed is selected and the ECU advances or retards the timing in order to keep the rpm near the target.

It is recommended to use this control always enabled and, if using electronic throttle or step motor set them as "Fixed Position" in order to achieve a better idle speed.



**Idle speed by timing reaction level:** the highest the value configured on this parameter, the more aggressive and with greater compensations the ECU will advance or retard timing when trying to avoid the RPM to drop. Such value varies greatly according to the engine configurations; therefore, it must be adjusted as needed. A very high value may cause the idle speed to oscillate when RPM drops; the opposite will cause the engine to turn off when an extra charge is requested.



**Timing Limits for Idle Control:** these values are limits for advance and retard when ECU is controlling the idle by timing.



### Adjusting Idle Speed by Timing

To start adjusting the idle by timing control, follow these steps:

1. Stabilize the idle speed rpm by using O2 sensor values a little richer than the stoichiometric (0,95 Lambda, 13,8 AFR (gasoline). Using a lean mixture on idle speed can cause the engine to shut off easily when extra load is required (A/C turning on or power steering, in example);
2. On the Main Ignition MAP start advancing timing, the idle will start to rise. Continue advancing timing until the idle stops rising. This timing value should be inserted in the **Maximum Timing Limit** parameter for idle speed. The **Minimum Timing Limit** should be set as  $-5^\circ$ ;
3. **Enable** the Idle by Timing Control, let the engine idle and check the timing at the ECU Dashboard. Usually, the best results are achieved with timing between  $0^\circ$  and  $10^\circ$  when idling. This way, the ECU has range to compensate if the rpm rises or falls;
4. If you notice that the timing is always working at the minimum or maximum programmed timing, you'll need to change the throttle position. If the timing is at the maximum limit, it is needed to open the throttle a little. Otherwise, if it's working always at minimum timing limit, you should close the throttle opening for idle a little bit;
5. The ideal work range for idle by timing is the medium point between Minimum and Maximum Timing;

**It is vital to idle by timing control** that the engine is equipped with a perfectly working and calibrated throttle position sensor (TPS). This control only starts working when TPS=0% and is automatically disabled when TPS leaves 0% position

### Idle speed control by step motor (FT400 only)

#### Automatic idle speed control

When the parameter "Automatic Idle Control" is selected, the throttle will automatically control idle speed, always attempting to keep the RPM close to the target-value indicated.

For a smooth idle speed, when using Idle Speed by Timing, select "Fixed Position" on idle control mode

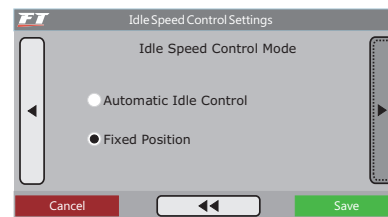

**Minimum position:** this is the first parameter to be set and it indicates the lowest position of the selected actuator in relation to the temperatures displayed on the screen. Values for the actuator position under other temperature ranges will be determined by interpolation. When using the electronic throttle, this is the minimum throttle opening in all conditions. The module will never allow the throttle opening to be lower than the values configured under this setting.

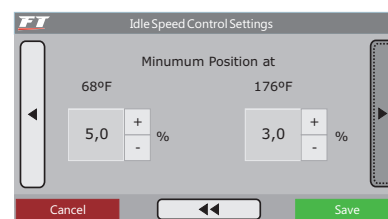

**Target idle RPM:** the next step must be to inform the target RPM for idle speed. That is the RPM that the module will maintain. Notice that there are two RPM fields, each one at one specific temperature range. Automatic interpolation performed by the module will determine the target RPM for all other temperature ranges.

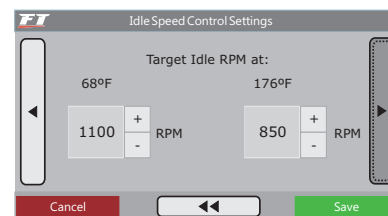

**Position on cranking:** this parameter determines the throttle opening whenever the engine is below 600rpm, usually at start. As soon as the engine reaches 600rpm, the Minimum Position and the Target Idle RPM are once again the determining parameters.

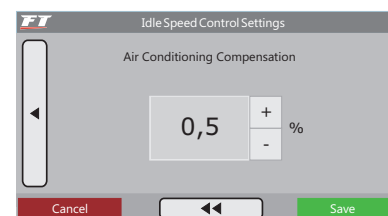

### Fixed position

A fixed opening configuration for the idle speed control is commonly requested by engines with extreme modifications and high profile camshaft. When selecting this option, the only parameters available for the idle speed control are **Minimum position** and **position on cranking**. When the

air conditioning output is configured, the Air Conditioning Compensation is also made available at the menu.

In this case, the value set for **Minimum position** is the selected actuator opening value, which will be used as idle speed. The **Position on cranking** option will be used only when the engine is below 600rpm. The Air **conditioning compensation** option can only be configured when one of the module's auxiliary outputs is configured as "Air Conditioning".

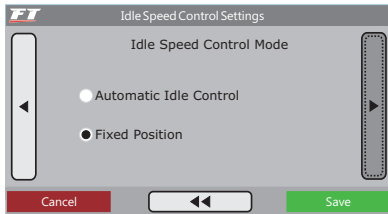

### Electronic throttle - idle speed control tuning suggestions (FT400 only)

For the idle speed automatic control to work properly with electronic throttle, some configuration and calibration adjustments are necessary:

1. Warm up the engine until its working temperature (194oF or until fan is turned on at least once);
2. Keep all equipment in the car turned off (lights, air conditioning, radio, etc.);

3. Having the **“Automatic idle control”** parameter **unchecked**, lower the **Minimum position at 176F** until the engine stabilizes at an ideal RPM for idle speed;
4. By doing so, the module is being informed of what is the minimum opening for the engine to keep itself turned on;
5. Once the steps above are completed, check the “Automatic Idle Control” option;
6. Start turning the vehicle's accessories/equipment on an off gradually and observe how the idle speed reacts. If the engine turns off at times, increase the value set under **“Idle speed reaction level”** and **“Minimum position”**.
7. A more advanced ignition timing (15o to 20o, depending on the engine) at the ranges immediately below idle speed (400-600rpm), improves the automatic control;
8. At ranges close to idle speed (from 800 to 1200rpm), use a more retarded ignition timing (sometimes, 0o is used) in order to have a smoother idle speed, with less variations.
9. O2 sensor values at idle speed must be very close to stoichiometric. This makes the engine more sensitive to automatic control, reducing the oscillations when there are RPM drops or when load varies. It is suggested to maintain the O2 values value close stoichiometric even when there are RPM variations.



**IMPORTANT NOTE:**

*when using the Automatic Idle Control, the ECU must have idle speed configured by **MAP** because the throttle opening will vary at idle, which makes the adjustment by TPS unviable.*

### Diagnose of idle speed anomalies

The automatic idle speed performs a precise control in order to keep the target RPM at all times; however, such control can be influenced by many factors. The table below shows some examples of cause and solution of problems common to this control:

Problem	Cause	Solution
Idle RPM oscillating*	- Idle Speed Reaction Level is too high - Mixture is too rich at idle speed - Timing too advanced	- Lower the value for the Idle Speed Reaction Level - Correct the mixture and retard timing at idle speed
Engine turns off when any accessory (A/C, fan, etc.) is turned on	- Idle Speed Reaction Level is too low, - Minimum Position is too low	- Increase the value for Idle Reaction Level - Increase timing at RPM ranges immediately below to idle speed (400-800rpm), - Increase the value for Minimum Position
Idle RPM is too high	- Minimum Position value is too high - False air intake at the intake manifold	- Lower the value for the Minimum Position (make sure to change the correct temperature range) - Check joints and manifold for false air intakes
Engine turns off at deceleration	- Minimum Position value is too low - Deceleration Cut Off RPM is too low	- Increase the value for the Minimum Position (make sure to change the correct temperature range) - Change the deceleration cut off - Increase timing at RPM ranges immediately below idle speed (400-800rpm)
Even after setting everything, step motor doesn't moves	- Incorrect wiring on step motor terminals	- Twist wires Brown/White #1 and Brown/White #2

Problem	Cause	Solution
Can't reduce idle rpm even with "Minimum Position = 0%"	- "Number of Steps" parameter with value lower than the correct for current step motor - False air intake at the intake manifold - Throttle open/stuck	- At the "Complementary Configurations" "Step Motor", increase the "Number of Steps" parameter under "Customized" option - Check joints and manifold for false air intakes - Completely close the throttle
Engine only idles with high values (20-40%) on "Minimum Position"	- "Number of Steps" parameter with value higher than the correct for current step motor	- At the "Complementary Configurations" "Step Motor", decrease the "Number of Steps" parameter under "Customized" option

- \* Idle speed may oscillate as a result of factors such as high profile camshafts, temperature, ignition timing, etc. To ensure that is not Automatic Control causing such oscillation, disable the Automatic Idle Control. The throttle will have a fixed position. Check if the RPM oscillation ceases or decreases. If not, changes to fuel and ignition maps will help greatly the Automatic Idle Control.
- \* The Automatic Idle Control works with a margin of error of 100rpm above and 50rpm below the configured target RPM. Therefore, these oscillations at idle speed are regarded as normal.
- \* It is important to highlight that a high profile camshaft causes a great variation in vacuum at idle speed. Those characteristics cannot be avoided completely and, therefore, oscillations at idle speed caused by a high profile camshaft are regarded as normal.

### 16.11 Shift alert

When the engine reaches the RPM set in this parameter, the screen will display a blinking message ("SHIFT") indicating that gear must be shifted.

To switch an external shift light, it is necessary to configure an auxiliary output at the "Input and Output Setup" menu. If no auxiliary output has been configured as Shift Light, the message "Output not configured!" will be displayed. Even so, it is possible to set the Shift Light RPM on the screen.

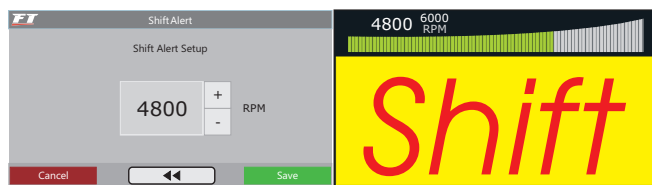

### 16.12 Fuel pump

This output activates the fuel pump through the negative terminal, connected to a relay. When starting the ignition, it is activated for six seconds, and it turns itself off if the module does not receive any RPM signal. The relay must be adequate to the current needed to switch the fuel pump.

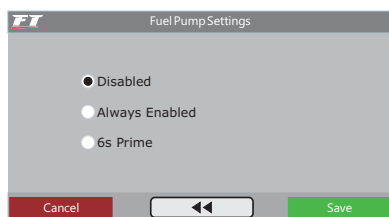

### 16.13 Variable camshaft control

This function allows the control of a variable valve timing control system (or a 2-gear automatic system). Select the output used to control the camshaft solenoid, and then, inform the RPM that the solenoid must be turned on.

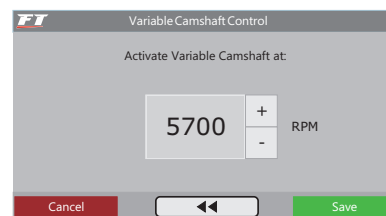

### 16.14 Progressive nitrous control

This auxiliary output configuration gives access to setting the ratio for the fuel-nitrous mixture (or nitrous only) through the pulse-width modulation (PWM) sent to the solenoids. The image below shows all the possible settings for this function:

Configure an auxiliary output as "Nitrous" at the "Input and Output Setup" menu. Then, select the option "Progressive Nitrous Control" at the "Input and Output Setup" menu. The first parameter to be configured is the TPS opening percentage, above which the injection of nitrous will be activated.

The next parameter is the percentage of fuel enrichment for 100% nitrous. Such percentage is applied to injection times, making them longer in order to keep up with the engine. The ignition retard is applied to the entire ignition table, which is necessary when there is nitrous injection.

Next is the nitrous injection map based on RPM. The highest the percentage configured in this map, the greater the amount of nitrous (or nitrous + fuel) injected. The maximum RPM is the same chosen on "Fuel Injection Setup". When using two banks of fuel injectors, enrichment is done over both banks.

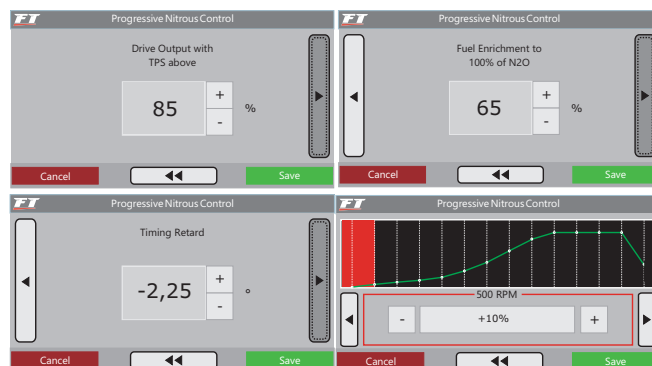

### 16.15 Boost control

To access the “Boost Control Settings”, it is necessary to configure an auxiliary output to control this function, which can be done at the “Input and Output Setup” menu.

This feature allows the control, through PWM, of a solenoid valve that manages the wastegate valve, therefore regulating the boost pressure. FuelTech recommends using a 3-way N75 solenoid. For more information about its installation, see chapter 8.7 in this manual.

The first parameter to be configured is the TPS percentage, above which the Boost Control will start to pulse the control solenoid. When TPS is below the percentage set, the solenoid remains inactive, allowing the engine to reach the pressure adjusted on the wastegate valve’s spring.

Select “LO for 0% Duty” when using a 3-way N75 solenoid, or any other solenoid that maintains the minimum boost pressure when inactive. This option is used in most cases.

Lastly, the maps are configured with the percentage of boost based on RPM, where 0% means that the valve is not activated and the boost pressure reached will be regulated by the valve’s spring, and 100%

means that the wastegate will be closed and the turbine will reach maximum pressure.



**IMPORTANT NOTE:**

*Be very CAUTIOUS when using this resource. When values close to 100% boost have been programmed, the turbine may generate full pressure, which may cause engine damage if it has not been properly prepared to support the pressure levels reached.*

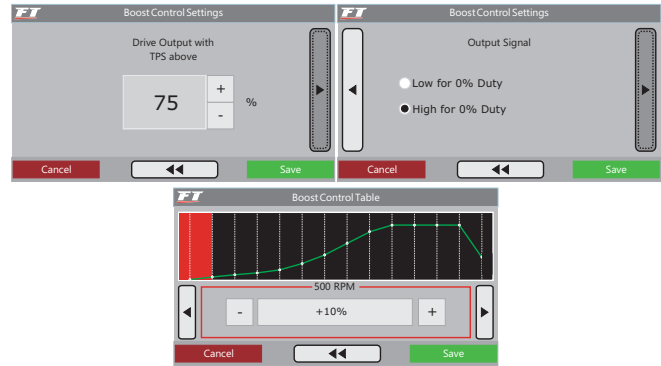

## 17. Input and output setup

The “Input and Output Setup” menu includes some adjustments that are usually made by the tuner when installing the module and do not require subsequent modifications, such as the definition of installed auxiliary outputs and sensor inputs, for example. The auxiliary outputs must be previously configured in this menu in order to be accessible through the “Aux Functions Adjust” menu.

All these auxiliary outputs are configurable and can actuate the electric fan, air conditioning, shift alert, fuel pump, variable valve control, progressive nitrous, boost control, or the idle speed actuator.

It is not possible to use Boost Control and Progressive Nitrous Control simultaneously, even when set up on different auxiliary outputs.

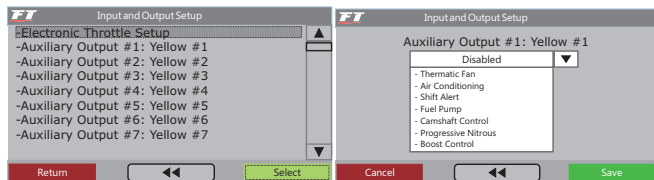
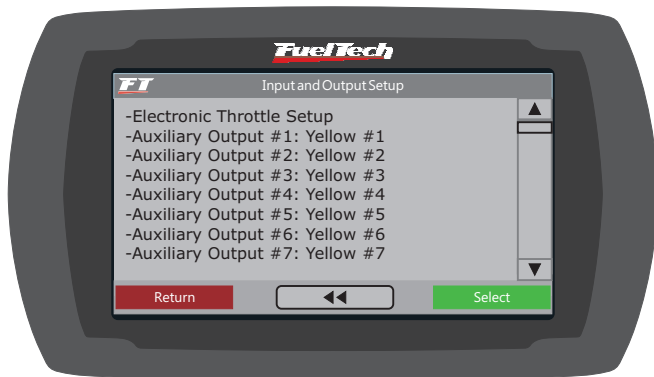
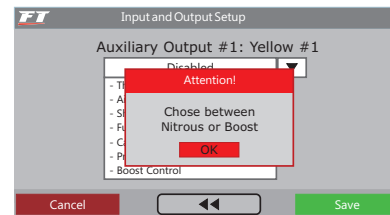

### 17.1 Electronic Throttle Control – ETC (FT400 only)

Once the throttle and pedal are correctly installed, the parameters for the ETC can be configured.

The first data to be entered in the module is the Throttle FT400 Code, which can be found in chapter 10.1 in this manual and it is different from the reference number found on the throttle body. In case the model of your throttle body is not listed therein, contact FuelTech technical support for further assistance. Click on “Edit Code” to inform the Throttle’s FT400 Code.



The next parameter to be configured is the Throttle Speed. There are five control modes:



**Normal:** normal speed of response, a little faster than the original control.

**Fast:** fast throttle response in relation to the pedal.

**Slow:** a smoother throttle control, ideal for automatic cars commonly used in city driving. This mode is the most indicated for reduction of pollution emissions because of its slower working pattern.

**Slow until 122F and normal when warm:** Slow up to 50 °C to facilitate the engine functioning at warming periods for engines running with ethanol. Above that temperature, it switches to the Normal mode.

**Slow until 122F and fast when warm:** Slow up to 50 °C to facilitate the engine functioning at warming periods for engines running with ethanol. Above that temperature, it switches to the Fast mode.

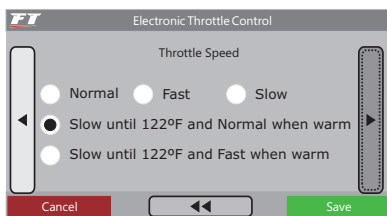

Then, select the **Operation mode**. This parameter alters the relation between the pedal and the throttle.

**Linear:** the throttle varies in accordance to the pedal variation; 1:1 rate, indicated for cars with manual gearbox.

**Progressive:** this mode was specially designed for street driving cars featuring automatic gearbox. Its progression makes for a smooth throttle actuation.

**Aggressive:** the rate between throttle and pedal is of 2:1. When 50% of the pedal is pressed, the throttle is already at 100%, generally used in engines featuring automatic gearbox.



The last parameter is the Maximum Throttle Position, which is very useful when limiting the vehicle's power is desirable. A value of 100% allows for complete throttle opening; lower values limit its opening.

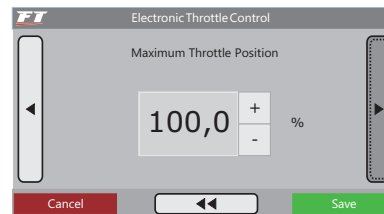

### Throttle body / Pedal calibration

Once the previous configurations have been completed, it is necessary to calibrate the electronic pedal and throttle. Under "Sensors and Calibration" menu select the option "TPS/Pedal Calibration". The following screen will be displayed:

#### Calibrating the electronic pedal:

- With the engine turned off and only the ignition key turned on, keep the electronic pedal at rest and press the "Calibrate" button by the "TPS = 0%" field.
- Push the electronic pedal to its maximum and press the "Calibrate" button by the "TPS = 100%" field.
- Release the pedal.
- Press "Save". If an error message is displayed, see chapter 11.3 in this manual for further information.

#### Calibrating the electronic throttle:

Whenever the calibration of the electronic throttle is performed, the electronic throttle automatically calibrates its opening and closing limit values. It is very important that the engine is turned off while throughout the calibration, as RPM will spike up to ignition cut-off.

Once these steps have been completed, it is necessary to adjust the idle speed parameters. Check chapter 16.10 in this manual

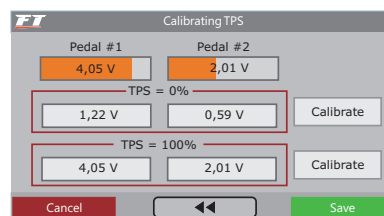

## 18. Alert settings

The configuration of alerts allows for the programming of sound and visual alerts whenever a dangerous situation to the engine is detected. It is possible to configure an engine cut-off if any alert is displayed on the screen.

Alerts can be individually configured for RPM excess, over boost, engine temperature, duty cycle, low oil pressure, high oil pressure, minimum oil pressure above a specific RPM, low fuel pressure and incorrect fuel differential pressure.

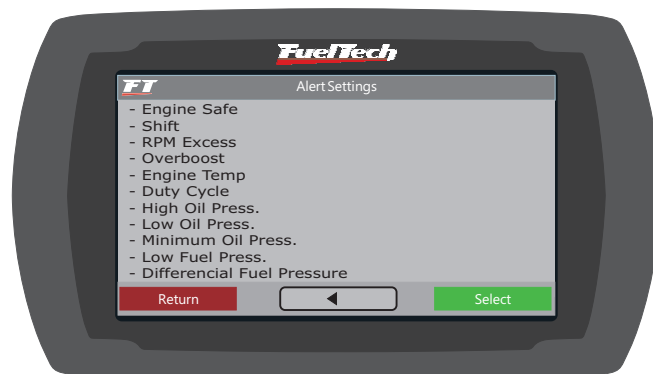

Anytime a warning is given by the injection, the screen will show a popup with the value information and the module emits a beeping sound and one of the texts below until the "OK" button, on the center of the screen, is pressed:

- RPM Excess: rpm
- Over boost: psi
- Engine Temperature: F
- Duty Cycle: % (informs which bank of injectors)
- High Oil Pressure: psi
- Low Oil Pressure: psi
- Low Fuel Pressure: psi
- Differential Fuel Pressure: psi

The warning regarding injector's duty cycle is configured by informing a percentage value of fuel duty cycle. The alert verifies both injector banks individually, indicating which one has exceeded the limit.

The "Engine Safe" menu allows for the configuration the engine cut-off if any warning is displayed on the screen. Two configuration options for engine protection are allowed:

**Alert only:** sound and visual alerts are shown, but the engine keeps working as usual;

**Shut engine off:** sound and visual alerts are shown and the engine is shut off. It will be turned on again only if the module is restarted.



## 19. Interface settings

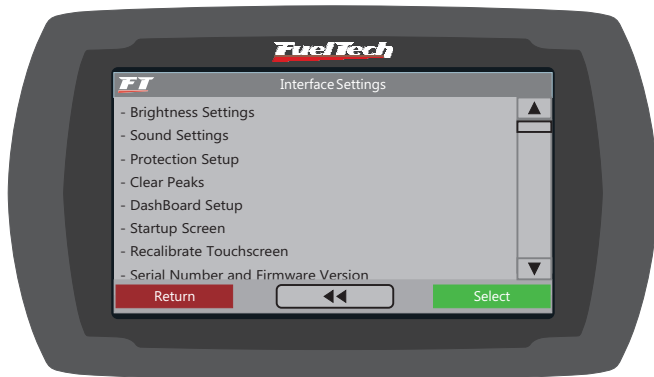

### 19.3 Protection setup

Passwords can only be accessed and altered when the engine is turned off. Two types of passwords can be set in the ECU:

#### User password

When activating the user password, it is possible to make 4 different types of adjustments for blocking and protection purposes:

- **Protection disabled:** this option must be selected when the user wants to insert a password but keep free access to all menus. It must be chosen to avoid that any password is inserted without the user's consent.
- **Protect adjust parameters:** with this option, all menus are protected against alterations. Open access is given only to read the information on the dashboard screen, and engine operation.
- **Block engine start:** this option blocks the engine start only. All menus are open for visualization and tuning, but the injection system is blocked until a password is inserted.
- **Protect adjust and engine start:** in this mode, engine start and the visualization and alteration of all injection parameters are blocked until a password is inserted.

### 19.1 Brightness settings

When adjusting the liquid crystal display (LCD) backlight, the intensity of the light can be altered to Day Light Mode or Night Light Mode.

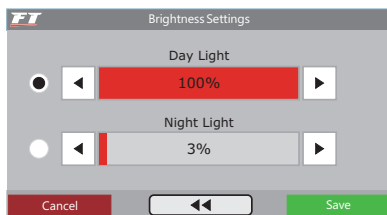

When touching the screen to enter the menu and a password has already been set and protecting the menus, the system will request it to be inserted to open access. Type the current password on the screen for access to be given until injection is restarted or the password is disabled.

### 19.2 Sound settings

This parameter allows for the setting the volume of sounds generated by touching the display. When the mute option is selected, the module does not emit the sounds when the screen is touched.

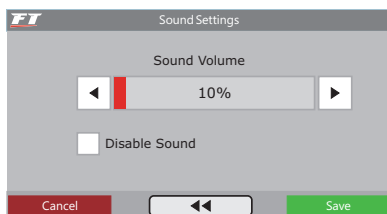

#### Tuner password

This password only blocks the "Fuel Injection and Ignition Tables Adjust", "Aux Functions Adjust", "Fuel Injection and Ignition Setup", "Input and Output Setup" and the "Sensors and Calibration" menus, letting open access to the

“Dashboard”, “Check Control Settings”, “Interface Settings”, “Diagnostic Panel” and “Files Manager. When this password is active, it is not possible to change any fuel injection or ignition map.



#### IMPORTANT NOTE:

*This ECU leaves FuelTech headquarters with all passwords disabled. Once inserting a protection password, the user will be blocking other people from accessing the injection system and even blocking him/herself. When choosing a password, make sure you will remember it, as, for safety matters, this password can only be changed at FuelTech headquarters (being the owner in charge of shipping the ECU along with its purchase invoice).*

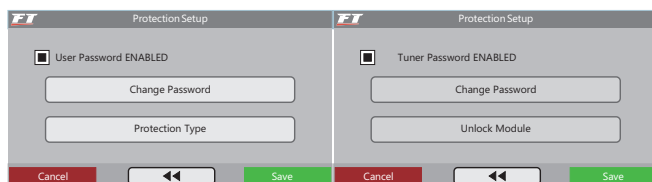

### 19.4 Clear peaks

At the Instrument Panel, values read by the sensors connected to the module are displayed in real time. On the bottom of each box on the display, the minimum (on the left) and maximum (on the right) values read by the sensor are shown.

It is possible to clear this data by accessing the option “Clear Peaks”, under the “Interface Settings” menu.



### 19.5 Dashboard setup

The Dashboard displays information collected by the sensors in real time. There are 6 positions available, allowing for the user to follow the engine information that he/she finds more important.

In order to make the information fixed on the dashboard computer, it is only necessary to click on the window and a list of instruments for display will be shown.

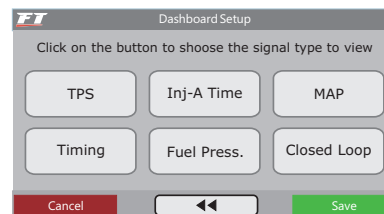

### 19.6 Startup screen

Select the screen shown as soon as the module is turned on. If the selected option is “Start using the Instrument Panel” and the module has a user password enabled, the module will request the password to be entered when the injection is turned on.

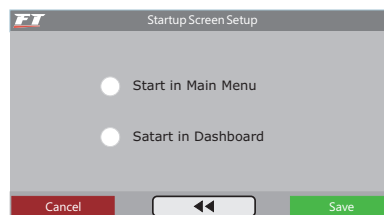

### 19.7 Recalibrate touchscreen

All electronic equipment with touch screen features a tool for the calibration of screen sensitivity. When calibrating the FT400 display, the user can use exact touch or inclusive touch, selecting the option to which he/she is better adapted.

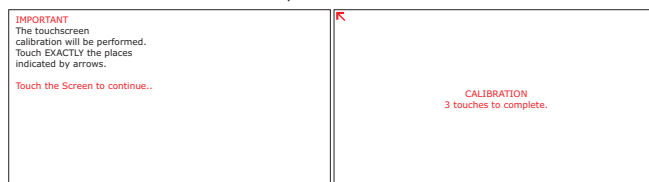

### 19.8 Serial number and software version

In this menu, it is possible to verify the software version and the equipment's serial number.

Make sure to have these numbers in hand whenever the FuelTech Technical Support is contacted to facilitate and optimize the assistance.

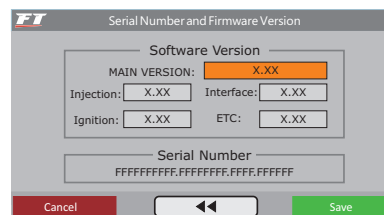

## 20. Files manager – memory positions and functions

The settings manager allows the user to alternate between the fuel injection maps saved in five memory positions, each one with different configurations and settings. Therefore, one could, for example, have five different settings for varied weather conditions or use. Another option is to use the same module for up to five different engines which may share the injection module but with their own adjustments and tunings saved. In that case, one or more extra cables may be requested.

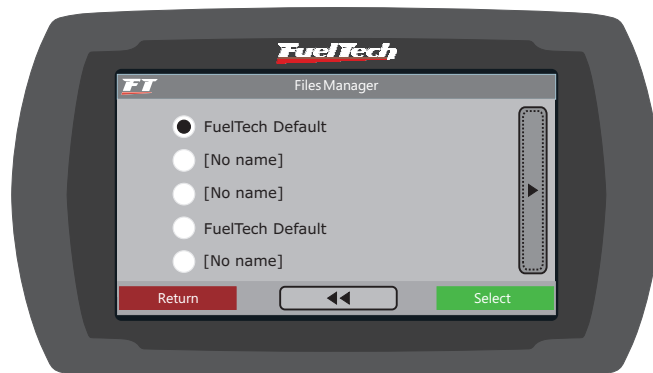

Automatic calculation of fuel injection tables function

The function "Copy FuelTech Standard Setting" is of great help when starting to tune a car, as it uses the data obtained from the Fuel Injection Configuration to estimate a fuel map that will serve as a basis for the adjustments.

Before using these functions it is very important that all the information and instructions given in chapter 11 in this manual have been followed thoroughly.

21. Rotary engines setup

The crank angle sensor (CAS) has two (2) trigger wheels that provide different signals to the ECU. As shown in picture, the bottom wheel is a 24 teeth trigger that provides the RPM signal and position of the eccentric shaft. The top wheel is a 2 teeth trigger that provides information of the position of the rotor.

FuelTech ECU will control the ignition timing using the reference of the 24 tooth wheel to spark the leading coil. All ignition timing programmed in the tables is referenced to the leading coil. Trailing coil will be fired using the programmed timing split parameter. This means that if the ignition timing in the main table is 0° and timing split is 10°, the ECU will fire the leading coil at 0° and the trailing coil 10° after leading coil was fired. The timing split parameter is fixed across all the ignition timing range.

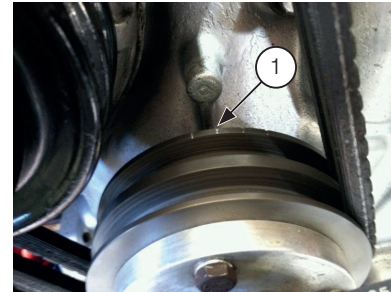
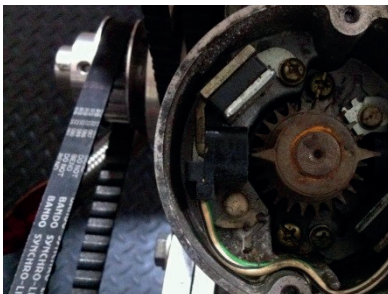

- 2. Align the Crank Angle Sensor to 0° using the mark in the shaft.

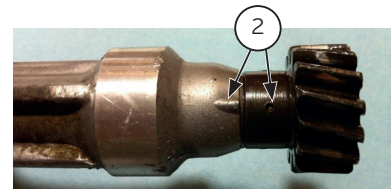

- 3. Install and tighten the Crank Angle Sensor in the engine. After the steps above are correctly followed, the Crank Angle Sensor should be aligned at TDC with the eccentric shaft.

21.2 Crank angle sensor wiring

The stock distributor will be read by FT as a Crank Angle Sensor and Camshaft Position Sensor. Here's how to connect the FT to your stock Mazda distributor:

21.1 Crank angle sensor installation and alignment

The Crank Angle Sensor needs to be installed in the engine at 0° (top dead center position). To align it, follow this quick step by step:

- 1. Use your ignition timing marks in the damper to align the eccentric to TDC. The ignition timing mark to be used is shown below.

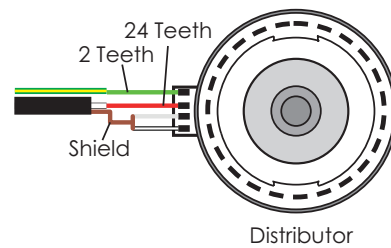

Function	Distributor wire	FuelTech wire	FuelTech pin
24 teeth signal (crank signal)	Red	White from shielded cable	17
2 teeth signal (home)	Green	Green/Yellow wire	15
24 teeth sensor negative	White	Shield from shielded cable	19
2 teeth sensor negative	White/Black		

For engines using trigger wheel instead of distributor, here are the connections:

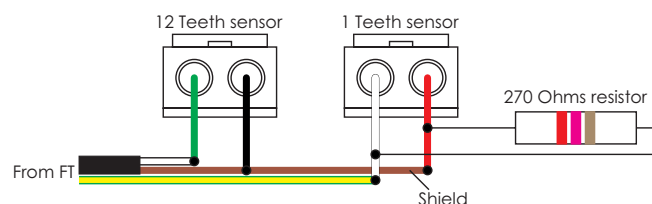

The use of the 270 Ohms resistor is mandatory

Function	Distributor wire	FuelTech wire	FuelTech pin
12 teeth sensor (crank signal)	Green	White from shielded cable	17
12 teeth sensor negative	Black	Shield from shielded cable	19
1 tooth sensor signal (home)	White	Green/Yellow wire	15
1 tooth sensor negative	Red	Shield from shielded cable	19

### 21.3 ECU setup

First, go to Fuel Injection Setup and enter the following:

- Max RPM: setup according to your engine;
- Injection mode: setup according to your engine;
- Idle by: TPS (fixed injection time on idle), MAP (injection time by MAP readings);
- Engine type: Rotary;
- Max boost pressure: setup according to your engine;
- Injectors banks: FT has two banks, setup how you want to use them (both as primary or A as primary and B as secondary);
- Acceleration fuel enrich: use by TPS, it's more accurate;
- Number of cylinders/rotors: setup according to your engine;

- Fuel injectors deadtime: if you don't have this info about your injectors, use 1,00ms;

Now, go to Ignition Setup and select:

- Ignition: Crank/Cam Ref. w/ Multi Coils;
- Crank Trigger Pattern: select option "12 (at crank) 24 (at cam)";
- First Tooth Alignment: 5 tooth BTDC;
- Crank Ref Sensor: Magnetic;
- Crank Ref Edge: Falling edge;
- Cam Sync Sensor: Magnetic;
- Cam Sync Polarity: Falling edge;
- Ignition Mode: Wasted Spark;
- Ignition Output Edge: see table below;
- Ignition Dwell: setup according to your coils, default is 3,60ms;
- Ignition Output Voltage: 12V.

### Ignition output edge

Ignition system	ECU ignition output edge
Spark Pro	Falling dwell (Inductive / SparkPRO)
MSD DIS-2(1)	Rising duty (CDI)
MW Pro-14/R(2)	Falling dwell (Inductive / SparkPRO)
MW-Pro Drag 4/R(3)	Falling dwell (Inductive / SparkPRO)

Notes:

1. Use two (2) ignition units
2. Considering that MW PRO-14/R trigger edge need to be configured as Falling Dwell leaving pins 9 to 10 unconnected. See page 9 of MW Ignition manual for more details
3. There is no set up the trigger edge of Pro-Drag 4/R. Trigger edge is Falling Dwell by default.

After setting up Fuel Injection Setup and Ignition Setup menus, make sure you go through chapter 11.3 to generate a fuel and timing base map for your engine.

### 21.4 Ignition coils wiring

After setting everything up, the ignition outputs of the ECU are ready to be connected to your coils or ignition modules. FT ECU ignition outputs cannot be connected directly to dumb coils, only to smart coils (coils with integrated ignition module) or ignition modules.

For 2 rotor engines, the gray wires are connected as the table below shows:

ECU ignition output	Function	Recommended SparkPRO-4 channel
Gray wire #A	Leading rotor #1 – Coil L1	Channel 1
Gray wire #B	Leading rotor #2 – Coil L2	Channel 2
Gray wire #C	Trailing rotor #1 – Coil T1	Channel 3
Gray wire #D	Trailing rotor #2 – Coil T2	Channel 4



For 3 rotor engines (FT400 only), the gray wires are connected as the table below shows:

ECU ignition output	Function	Recommended SparkPRO-6 channel
Gray wire #A	Leading rotor #1 – Coil L1	Channel 1
Gray wire #B	Leading rotor #2 – Coil L2	Channel 2
Gray wire #C	Leading rotor #3 – Coil L3	Channel 3
Gray wire #D	Trailing rotor #1 – Coil T1	Channel 4
Gray wire #E	Trailing rotor #2 – Coil T2	Channel 5
Gray wire #F	Trailing rotor #3 – Coil T3	Channel 6

Please, make sure the correct ignition output wire of the ECU is connected to the corresponding ignition coil as shows the table above. Also, be sure to check the wiring schematic on chapter 22 on this manual.

### 21.5 Calibration of the crank angle sensor ignition timing

- 3 - 10° ATDC
- 4 - TDC

If all above steps were correctly completed is time to crank the engine to start. Do not make any modification to the base map ignition timing. The engine should start using the base map.

After the engine starts, the calibration of the ignition timing needs to be performed. Go to “Sensors and Calibrations” menu and then “Ignition Calibration”. By entering this screen, the ECU locks the ignition timing to 20°.

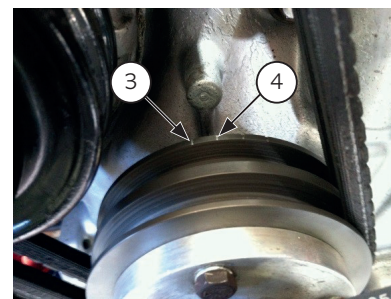
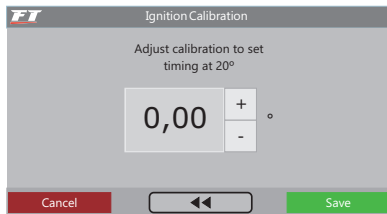

Figure 2 – TDC and 10°ATDC Ignition Timing Marks

Timing light will be used to read ignition timing marks in the damper and spark on Leading Rotor #1.

Put your timing light on 0° and advance or retard timing on the calibration screen until the timing on damper aligns with the 20° BTDC mark. When that’s correct, the calibration is done.

If your timing light has an advance/retard knob, you can advance it to 20° and check timing by 0° (TDC) mark.

To check timing on the Trailing spark plug, switch timing light from spark plug. If your timing split is 10°, you should read 10° BTDC on the damper.

- 1 - 10° BTDC
- 2 - 20° BTDC

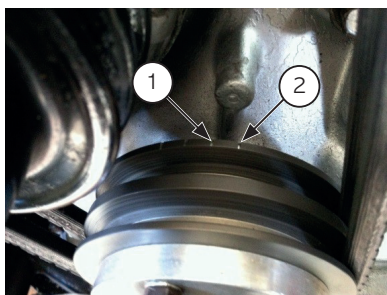

Figure 1 – 10° BTDC and 20° BTDC Ignition Timing Marks

After ignition timing calibration is performed your engine is ready for tuning. The default map should be a point to start tuning only. Be careful when tuning your engine and never full throttle it before it’s properly tuned. Always start the tuning with a rich map and conservative ignition timing. A lean engine with aggressive timing will lead to serious engine damage. A rich engine with aggressive advanced timing could lead to serious engine damage also.



## 22. Full wiring diagram

### 8 cylinder engine with FT400, SparkPRO-4 and crank trigger wheel

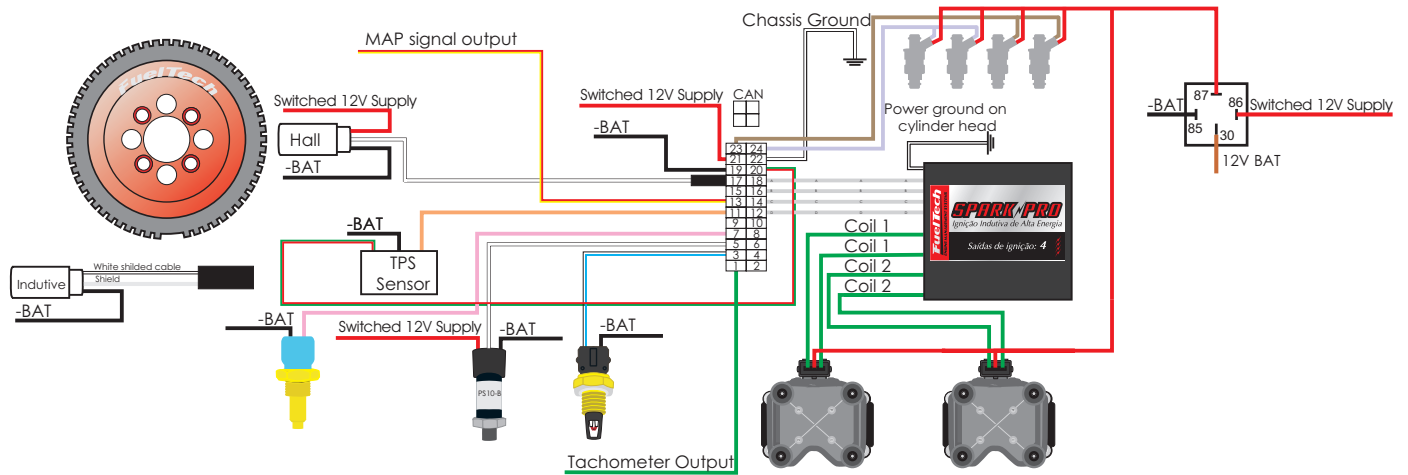

### 2 rotor engine – original distributor – SparkPRO-4

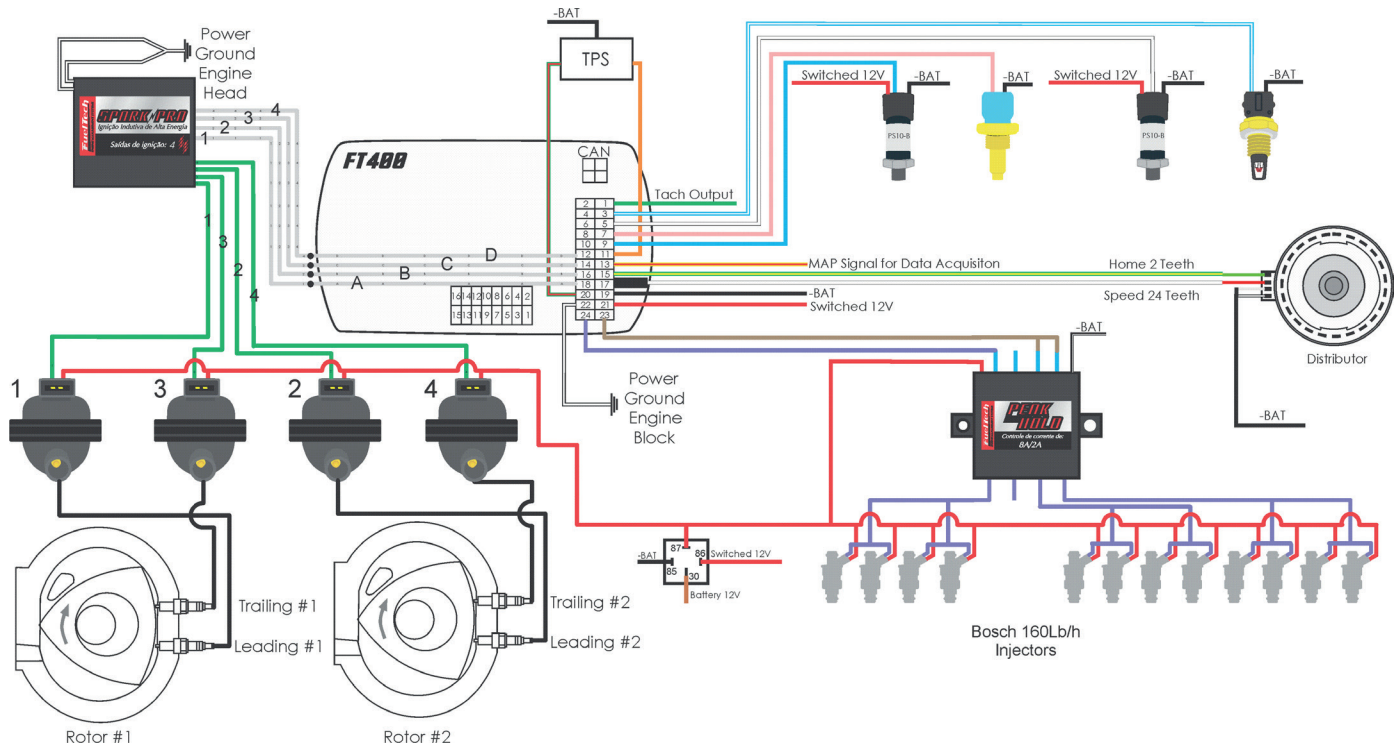

FT350/FT400 - SparkPRO-1 - hall distributor - Coil 2 wires

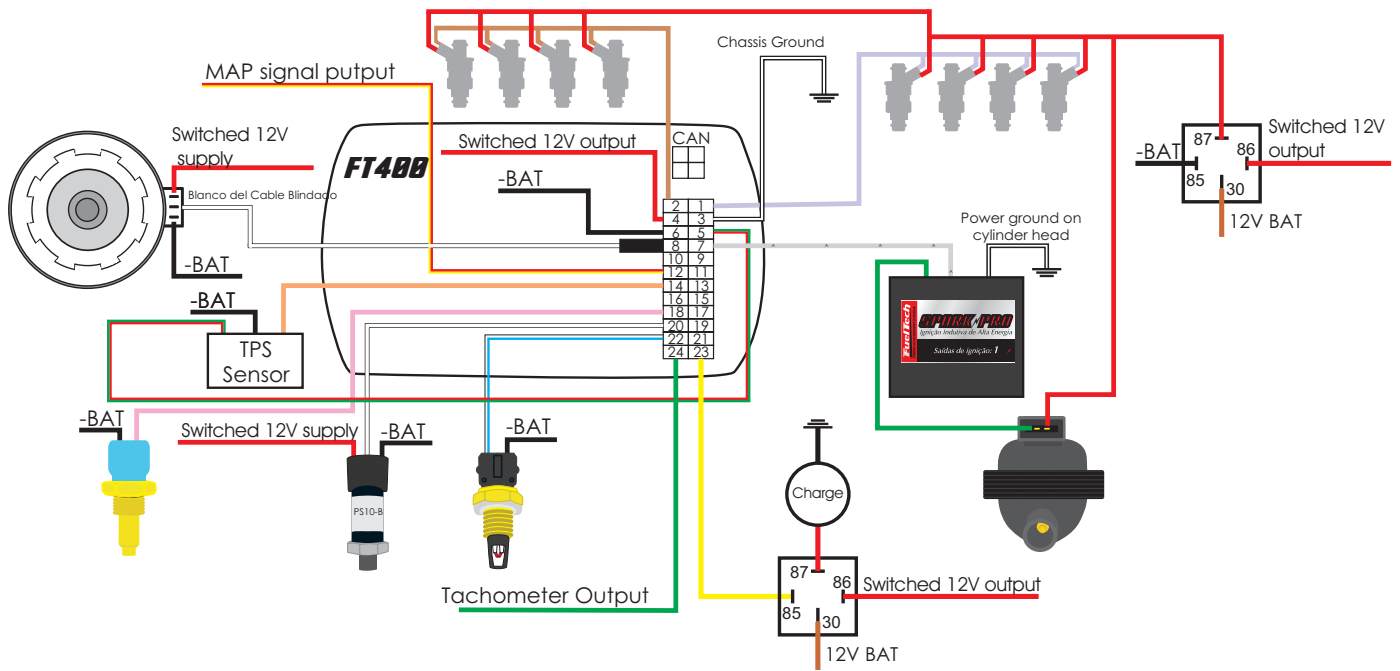



***FuelTech***

**USA**

455 Wilbanks Dr.  
Ball Ground, GA, 30107, USA

Phone: +1 678-493-3835  
Toll free: +1 855-595-3835  
Email: [info@fueltech.net](mailto:info@fueltech.net)  
[www.fueltech.net](http://www.fueltech.net)