

OWNER'S MANUAL

NANO PRO

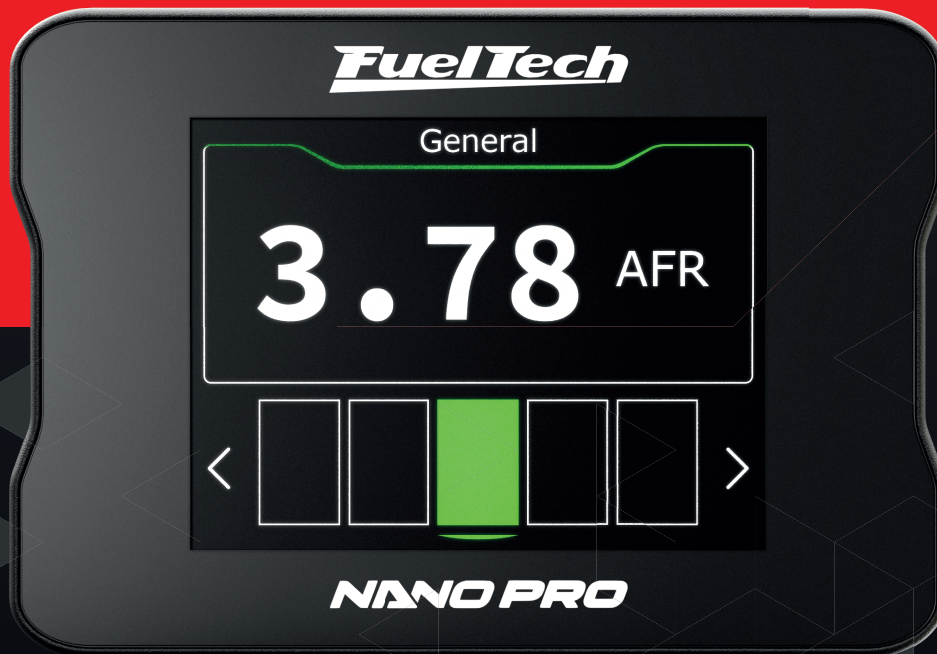

FuelTech

Index

1. Presentation	3	9. Configuration via the FTManager interface	20
2. Warnings and warranty terms	4	9.1 Datalogger channels	21
3. Characteristics	5	9.2 Nano PRO software update	22
3.1 Package contents	5	10. Lambda readings analog outputs	23
4. Nano PRO electrical installation	6	10.1 Lambda analog output in Volts – 5.14 to 17.6 AFR	23
4.1 Adapter harnesses	7	10.2 Lambda analog output in Volts – 8.7 to 16.2 AFR (default)	23
4.2 Replacement of Bosch LSU sensor connector 4.2 for 4.9	7	10.3 Lambda analog output in Volts – 9.6 to 19.1 AFR	23
4.3 Replacement of Bosch LSU sensor connector 4.2 for 5.2	8	10.4 Lambda analog output in Volts – 9.6 to 58.8 AFR	23
4.4 Replacement of Bosch LSU sensor connector 4.2 for NTK	9	10.5 Lambda analog output in Volts – 9.6 to 146.9 AFR	23
5. Wide band O2 sensor	10	11. Analog output lambda/AFR	23
5.1 Bosch LSU 4.2 O2 sensor	10	12. Nano PRO codes	24
5.2 Bosch LSU 4.9 O2 sensor	10	12.1 Informative codes	24
5.3 Bosch LSU 5.2 O2 sensor	10	12.2 Error codes	24
5.4 NTK O2 sensor	10	13. Fixing template (in)	25
5.5 O2 sensor installation	11		
5.6 O2 sensor for use in Diesel powered vehicles	11		
6. OBD-II harness installation	12		
6.1 Harness identification	12		
6.2 OBD-II connector identification	12		
7. CAN communication	13		
7.1 FT CAN 2.0	13		
7.2 FT CAN 1.0	13		
8. Configuration through the Nano PRO interface	14		
8.1 Dashboard configuration	14		
8.2 Display configuration	15		
8.3 Heating setup	16		
8.4 O2 sensor configuration	16		
8.5 Manual	17		
8.6 Language	17		
8.7 About	17		
8.8 Settings	17		

1. Presentation

FuelTech Nano PRO is a tool used for monitoring and datalog of air to fuel ratios on combustion engines. The device is able to read and share with the ECU the following oxygen sensors: Bosch LSU 4.2 / Bosch LSU 4.9 / Bosch 5.2 and NTK wide-band sensor.

Besides its multiple types of O2 sensors compatibility, the Nano PRO is also a dashboard, allowing the configuration of up to 5 screens to display information sent by the ECU (FTCAN 2.0), or work as button to activate various ECU functions.

FuelTech Nano PRO allows communicating with the FT300, FT350 and FT400 through the FTCAN 1.0 protocol, transforming the Nano PRO into an auxiliary dashboard.

Monitor the engine's air/fuel mixture and explore the complementary features, displaying complementary info or saving inputs by activating buttons through its screen.

The new Nano PRO is fully compatible with the WB-O2 NANO harness, sharing same connector and pinout.

When stand-alone, the display will only show the air/fuel mix information.

The Nano PRO provides the functionality to read original vehicle parameters through the OBD-II diagnostic port in original vehicles. It is essential to note that this tool is only compatible with the ISO15765-CAN protocol and does not support other protocols.

To use the Nano PRO with OBD-II, you will need to have the special harness, which includes the OBD connector and a wire that must be connected to the vehicle's ignition-switched power source.

Bosch sensors are self-calibrating, while NTK sensors require an air free calibration, see the manual for information about the procedure.



IMPORTANT

After the Bosch LSU sensor is installed make sure you select the correct sensor. This will prevent sensor damage and reading errors.

There are differences between AFR (air fuel ratio) from the Bosch LSU Sensor 4.2 and 4.9, so it's necessary to correctly configure the Bosch LSU Sensor type.



2. Warnings and warranty terms

The use of this equipment implies the total accordance with the terms described in this manual and exempts the manufacturer from any responsibility regarding to product misuse.

Read all the information in this manual before starting the product installation.

This product must be installed and programmed by specialized auto shops and/or personnel with experience on engine preparation and tuning.

Before starting any electrical installation, disconnect the battery.

The inobservance of any of the warnings or precautions described in this manual might cause engine damage and lead to the invalidation of this product warranty. The improper adjustment of the product might cause engine damage.

This product does not have a certification for the use on aircrafts or any flying devices, as it has not been designed for such use purpose.

In some countries where an annual inspection of vehicles is enforced, no modification in the original fuel injection system is permitted. Be informed about local laws and regulations prior to the product installation.

Limited warranty

All products manufactured by FUELTECH are warranted to be free from defects in material and workmanship for one year following the date of original purchase. Warranty claim must be made by original owner with proof of purchase from authorized reseller.

This warranty does not include sensors or other products that FUELTECH carries but did not manufacture. If a product is found defective, such products will, at FUELTECH's option, be replaced or repaired at cost to FUELTECH. All products alleged by Purchaser to be defective must be returned to FUELTECH, postage prepaid, within one year warranty period.

This limited warranty does not cover labor or other costs or expenses incidental to the repair and/or replacement of products or parts.

This limited warranty does not apply to any product which has been subject to misuse, mishandling, misapplication, neglect (including but not limited to improper maintenance), accident, improper installation, tampered seal, modification (including but not limited to use of unauthorized parts or attachments), or adjustment or repair performed by anyone other than FUELTECH.

The parties hereto expressly agree that the purchaser's sole and exclusive remedy against FUELTECH shall be for the repair or replacement of the defective product as provided in this limited warranty. This exclusive remedy shall not be deemed to have failed of its essential purpose so long as FUELTECH is willing and able to repair or replace defective goods.

FUELTECH reserves the right to request additional information such as, but not limited to, tune up and log files in order to evaluate a claim.

Seal violation voids warranty and renders loss of access to upgrade releases.

Manual version 1.5 – March/2024

3. Characteristics

- Water proof (IP67 Certified)
- 2" display with resistive touchscreen
- Lambda readings shown on the display (2.94 to 146.9 AFR Gas)
- CAN communication with all ECU's (FTCAN 1.0 and FTCAN 2.0)
- Analog output 0-5V
- Compatible with Bosch 4.2 / 4.9 / 5.2 O2-sensors and NTK sensor
- Configurable operating range
 - Lambda (0.21 - 9.99)
 - AFR Methanol (1.35 - 64.6)
 - AFR Gasoline (3.09 - 146.9)
 - AFR Ethanol (1.89 - 89.9)
- Dimensions: 2.64" x 1.83" x 1.48" (in)

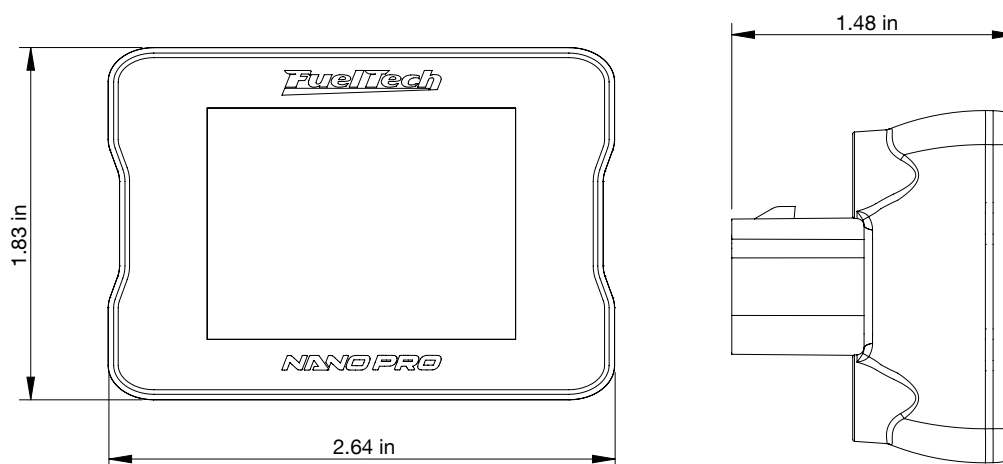

3.1 Package contents

- Nano PRO module
- Instructions manual
- 4 screws with washers (M4 x 6 PHILLIPS and M4 flat washers)



IMPORTANT
Installation MUST use the screws that come with the product. Out of specification screws may damage the housing, causing loss of warranty.

4. Nano PRO electrical installation

The Nano PRO has a 12-way connector with 3 wire groups. One of them has the connector for the O2 sensor, the second makes the CAN communication with PowerFT ECU's and the third is responsible for power and analog output.

By default, the analog output is set to values of 8.7AFR to 16.2AFR Gas, but can be configured to 5.1AFR to 17.6AFR Gas or 9.6AFR to 19.1AFR or 9.6AFR to 58.8AFR or yet 9.6AFR to 146AFR (Gas), if necessary.

See the following wiring diagram for details about connections.



IMPORTANT
Nano PRO has an accurate diagnosis that requires a good electrical installation, therefore, it may be necessary to review and reinforce the harness, especially in the battery and power grounds.

12-way connector

Wire color	Pin	Connection	OBS to Connections
	1	O2 sensor	O2 sensor - IP
	2	O2 sensor	O2 sensor - sensor negative signal
	3	O2 sensor	O2 sensor - Sensor positive signal
	4	Switched 12V	The use of a 10A fuse is recommended
	5	0-5V Analog Output	Analog output proportional to the lambda readings. Used for connection with data acquisition systems
	6	CAN	CAN (+): connected to PowerFT ECU's CAN port
	7	O2 sensor	O2 sensor - sensor resistor calibration
	8	O2 sensor	O2 sensor - sensor heater positive
	9	O2 sensor	O2 sensor - Sensor heater negative signal
	10	Chassis/Engine Power Ground	Engine ground (head/block) Do not connect it directly to the battery negative.
	11	Battery's Negative	Connected directly to the battery negative with no splices. Do not connect this wire to the chassis engine block or head.
	12	CAN	CAN (-): connected to PowerFT ECU's CAN port

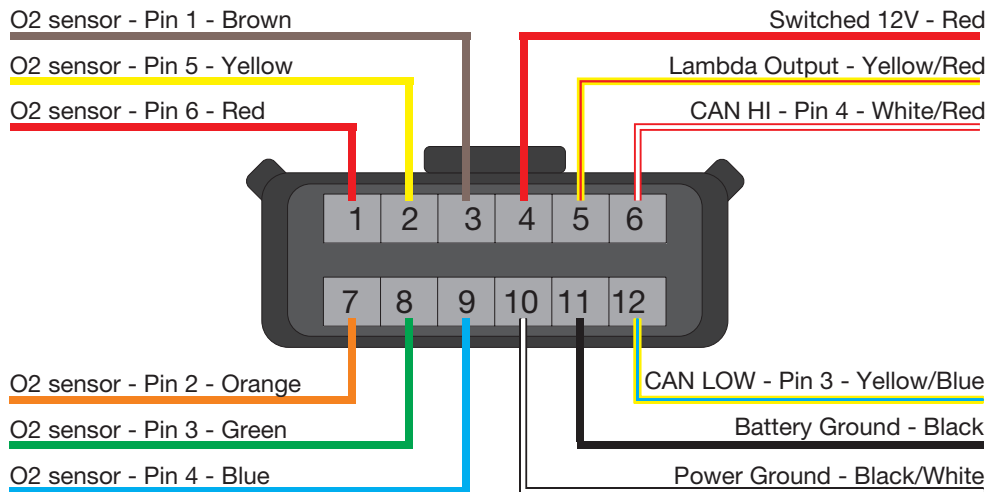

Harness connector rear view
 O2 Sensor LSU 4.2

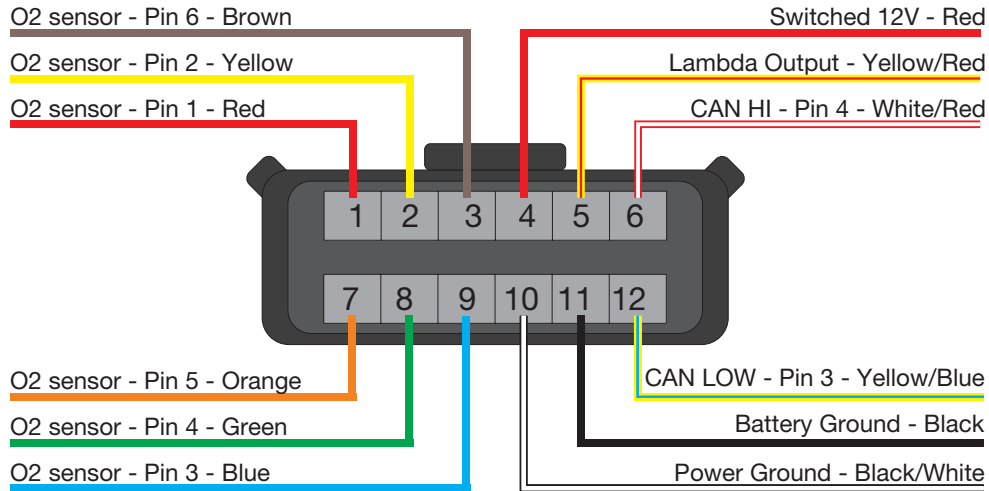

Harness connector rear view
O2 Sensor LSU 4.9

4.1 Adapter harnesses

The harness of the Nano PRO is the same as the WB-O2 NANO and is prepared for connection with a Bosch LSU 4.2 sensor. To use other conditioners, it is necessary to purchase the specific harnesses for each one of them. It is also possible to buy just the connector kits to replace the LSU 4.2 plug with another one.



4.2 Replacement of Bosch LSU sensor connector 4.2 for 4.9

This procedure is necessary if you want to use a Bosch LSU 4.9 sensor in a Bosch LSU 4.2 sensor harness. Refer to table below for sensor pinout:

Connector Nano PRO (Wire color) - (pin)	Function wire sensor	Connector Bosch LSU 4.2 (Pin)	Connector Bosch LSU 4.9 (Pin)
1 - Red	IP	6	1
2 - Yellow	Ground sensor signal	5	2
3 - Brown	Positive sensor signal	1	6
7 - Orange	Calibration resistor sensor	2	5
8 - Green	Heat positive signal sensor	3	4
9 - Blue	Heat ground signal sensor	4	3



Connector Bosch LSU 4.2

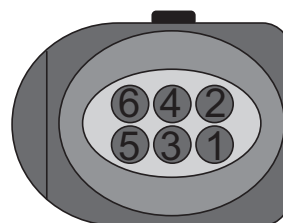

Connector Bosch LSU 4.9

Harness connector rear view



IMPORTANT

The Nano PRO is factory configured to suit the Bosch LSU 4.2 sensor, if you want to use another sensor, you need to change the configuration in the Nano PRO software. This will prevent the sensor from being damaged or reading errors occurring.



WARNING

NEVER disconnect the O2-sensor with the Nano PRO powered, this could damage the equipment.

Bosch LSU 4.9 electrical diagram

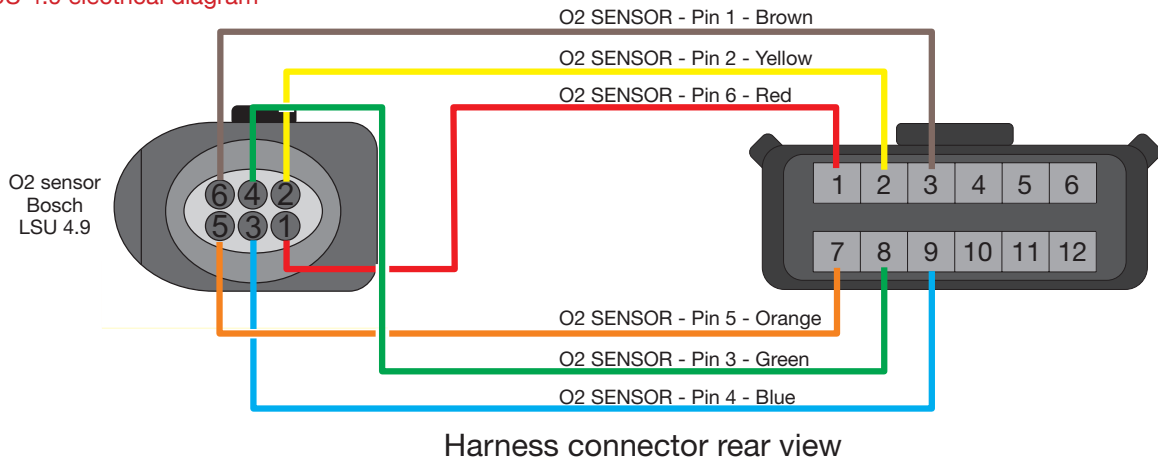

4.3 Replacement of Bosch LSU sensor connector 4.2 for 5.2

This procedure is necessary if you want to use a Bosch LSU 5.2 sensor in a Bosch LSU 4.2 Sensor harness. Refer to table below for sensor pinout:

Connector Nano PRO (Wire color) - (pin)	Function wire sensor	Connector Bosch LSU 4.2 (Pin)	Connector Bosch LSU 5.2 (Pin)
1 - Red	IP	6	5
2 - Yellow	Ground sensor signal	5	4
3 - Brown	Positive sensor signal	1	1
7 - Orange	Calibration resistor sensor	2	6
8 - Green	Heat positive signal sensor	3	2
9 - Blue	Heat ground signal sensor	4	3



Connector Bosch LSU 4.2

Harness connector rear view



Connector Bosch LSU 5.2

Bosch LSU 5.2 electrical diagram

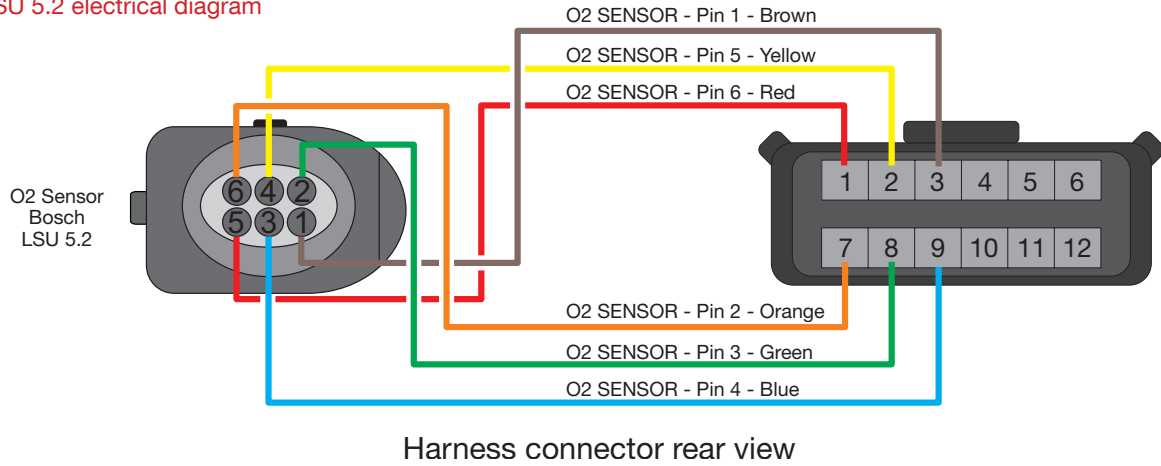

4.4 Replacement of Bosch LSU sensor connector 4.2 for NTK

This procedure is necessary if you want to use a NTK sensor in a Bosch LSU 4.2 Sensor harness. Refer to table below for sensor pinout:

Connector Nano PRO (Wire color) - (pin)	Function wire sensor	Connector Bosch LSU 4.2 (Pin)	Connector NTK Sensor
1 - Red	IP	6	3
2 - Yellow	Ground sensor signal	5	1
3 - Brown	Positive sensor signal	1	5
7 - Orange	Calibration resistor sensor	2	-
8 - Green	Heat positive signal sensor	3	8
9 - Blue	Heat ground signal sensor	4	6



Harness connector rear view

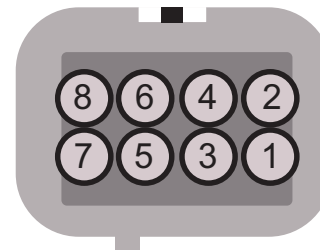

NTK Sensor electrical diagram

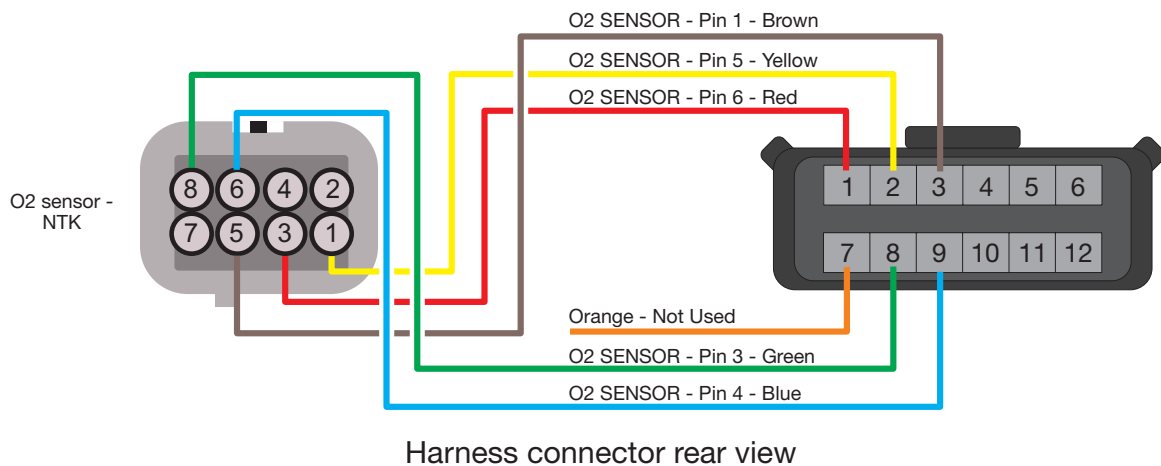

5. Wide band O2 sensor

Better known as the oxygen sensor, it is responsible for reading the exhaust air/fuel ratio. This sensor is essential for engine fine tuning.

NOTE



Running the engine with the sensor installed to the exhaust and not connected to the Nano PRO (or other conditioner) may damage the sensor.

5.1 Bosch LSU 4.2 O2 sensor

Bosch LSU 4.2 sensor has an encased heating element and it is used to measure the air fuel ratio, which determines the lambda value in the remaining exhaust gas. Its signal indications vary from 5.14AFR Gas (0,35 λ) lambda (rich mixture) to open air lambda (infinite).

The connector includes a calibration resistor (factory calibrated), which defines the characteristics of the sensor and it is necessary for its operation. It is with this resistor that the WB-O2 Nano automatically calibrates the sensor.



Part number Bosch (Brazil): 0 258 007 057 or 0 258 007 351
VW: 021-906-262-B

5.2 Bosch LSU 4.9 O2 sensor

The Bosch LSU 4.9 O2 sensor works the same as the 4.2



Part number Bosch (Brazil): 0 258 017 025

5.3 Bosch LSU 5.2 O2 sensor

The O2 sensor Bosch LSU 5.2.



Part number Bosch (Brazil): 1 928 404 719



IMPORTANT

Bosch LSU oxygen sensors are not designed to run on fuel that contains lead, and their lifespan is drastically reduced to around 50 to 500 hours.

5.4 NTK O2 sensor

This O2 sensor is used in engine laboratories, due to its extreme accuracy and speed in reading in different AFRs.

This O2 sensor requires an free-air calibration.



Part Number FuelTech: 5005100011

Free-air calibration

The NTK O2 sensor needs an open air calibration, so after configuring in the software it is necessary to connect the sensor to the Nano PRO and carry out the calibration.

To perform this procedure, first connect the O2 sensor to the Nano PRO and leave it out of the exhaust. Turn the ignition on, and let the NTK O2 sensor heat up for 5 minutes, then access the sensor setup menu, select NTK, and click on the "calibrate" button.

The calibration process is executed 5 times to guarantee the expected result, after the test a message with the result will appear on the screen. If an error message is displayed, it is necessary to repeat the calibration procedure.

5.5 O2 sensor installation

The sensor must be inserted in the exhaust system with its tip exposed to the exhaust gas flow. It must stay in an angle between 10 to 80 degrees to horizontal position, that is, with its end downward, in such a way that steam droplets cannot be accumulated between the body of the sensor and its ceramic part, which could cause damage when the sensor is used. The sensor must not be placed vertically, as it becomes subject to excessive heat.

It is recommended that the sensor is installed at least one (1) meter away from the exhaust manifold to avoid excessive heat, and at least one (1) meter away from the exhaust external output to avoid incorrect readings caused by oxygen in the air outside the exhaust system.

Notice that such recommendations are not obligatory, as vehicles with a smaller exhaust system will need to have the sensor placed closer to the engine.

The sensor must stay away from the cylinder head and from areas where one cylinder might affect the exhaust air more than the others must. Avoid placing the sensor close to the exhaust manifold joints, as some allow the inflow of air, resulting in incorrect readings.

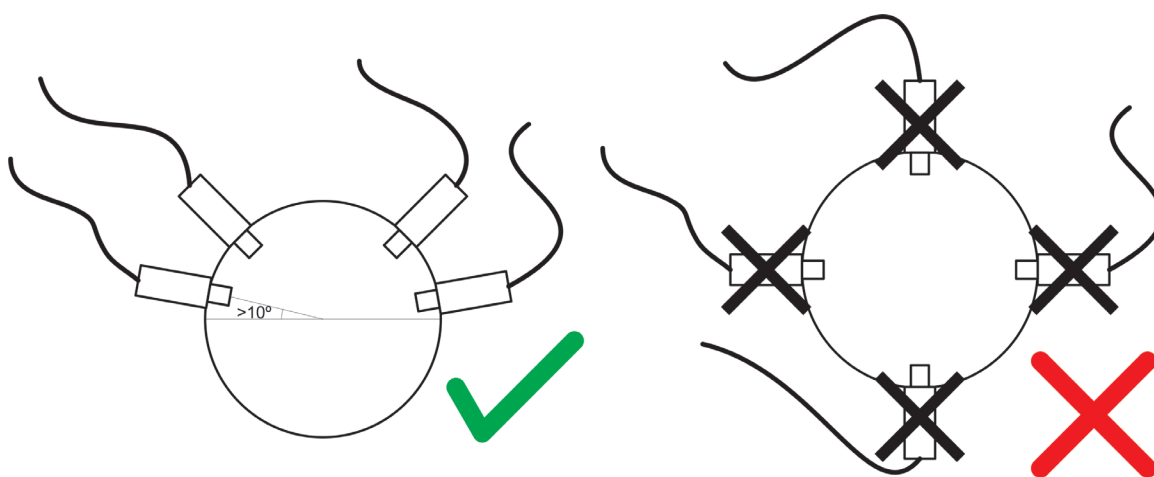

5.6 O2 sensor for use in Diesel powered vehicles

The Nano PRO allows readings of various fuels including engines fed with oil Diesel as fuel, in this case the recommended O2 sensor are Bosch LSU 4.2 and 4.9.

For use in Diesel, it is necessary to take some precautions so as not to reduce the useful life of the probe, they are:

- AFR Diesel values between 11.60 and 15.95 are the maximum power for oil Diesel.
- It's recommended to use AFR Diesel values upper than 18.85 where the exhaust gas temperature is lower.
- Black smoke is an indication of an extremely rich mixture and this particulate will drastically reduce the useful life of the O2 sensor.

6. OBD-II harness installation

To use the Nano PRO as an OBD-II display, it is necessary to obtain the specific harness for this purpose.

6.1 Harness identification

- 1 - OBD-II connector
- 2 - Nano PRO connector
- 3 - 12V switched connector (T-Tap wire connector)

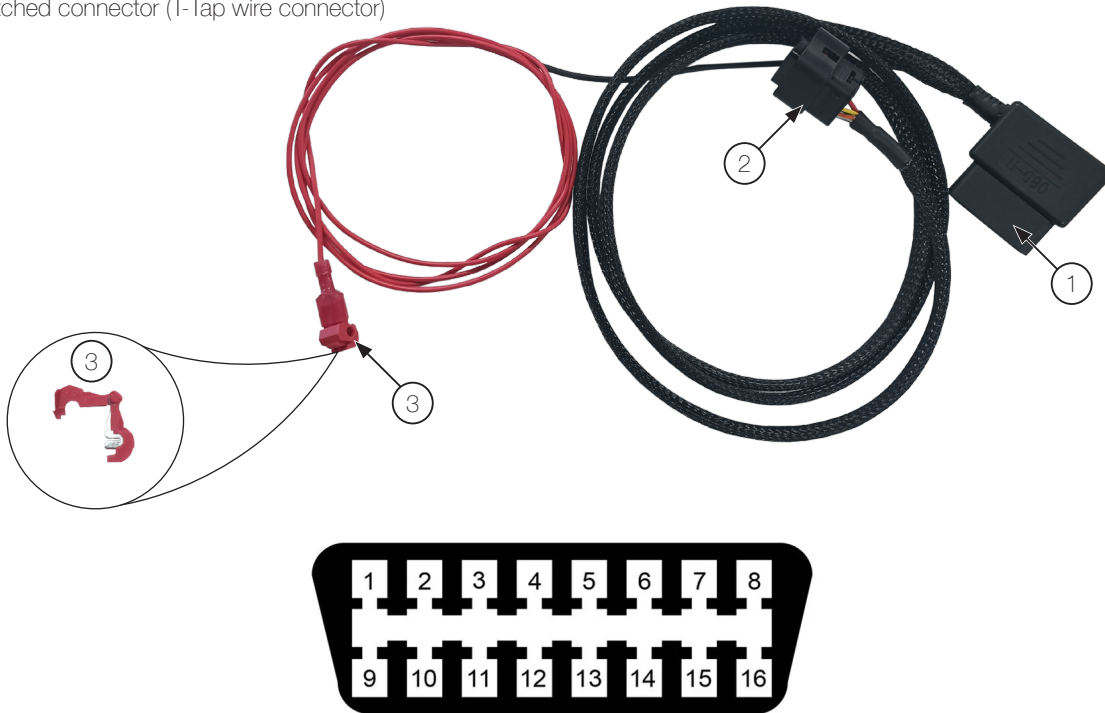

6.2 OBD-II connector identification

- 4 - Chassis ground
- 5 - Signal ground
- 6 - CAN HIGH
- 14 - CAN LOW
- 16 - 12V Battery

The other pins of the OBD-II port are not used by the Nano PRO.



IMPORTANT

Nano PRO is ONLY compatible with the ISO15765-CAN protocol.

7. CAN communication

7.1 FTCAN 2.0

The Nano PRO has CAN communication, which allows the module to send and read information from the PowerFT ECU's that are also connected in the network. Included on the Nano harness are two 4-way CAN connectors that plug and play with other Nano PRO units as well as the PowerFT ECU's.

When connected to the CAN port, the Nano PRO can read what the fuel and the measurement unit (lambda or AFR) that the ECU is set, adjusting itself to these settings, disabling the analog output and sending the AFR value to ECU in the range of 2.94 to 149.9 AFR Gas.

In the CAN network, during the O2 sensor heating period, the value displayed in the PowerFT ECU's will be equal to 0 (zero) and the back of lambda gauge will turn yellow.

Sample rate: 100Hz

In case of any error during work, in addition to the warning on Nano PRO display, the error will be sent via CAN to the PowerFT ECU's and recorded in "Status Events" log.

To connect the Nano PRO via CAN to PowerFT ECU's simply plug the 4-way cable to the ECU CAN port.

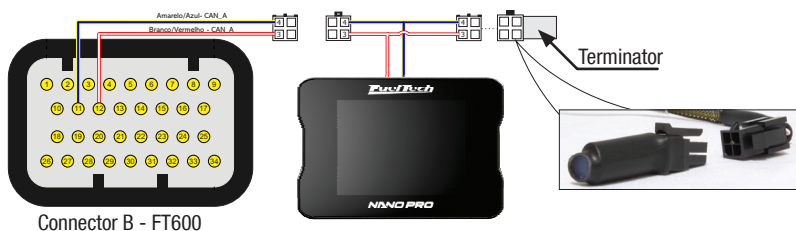

7.2 FTCAN 1.0

FuelTech Nano PRO also features FTCAN 1.0 communication, which allows you to receive information from the old line ECUs such as FT250, FT300, FT350 and FT400.

To connect the Nano PRO to FT ECU from the old line, it is necessary to use the same communication port as the USB CAN cable, that is, to use the Nano PRO, it is necessary to disconnect the USB CAN cable from the ECU.

The Lambda sensor reading will still be done by the analog output, being necessary to make the electrical connection of the ECU with the Nano PRO through pin 5 (yellow/red wire).

The channels sent by the ECU to Nano PRO are as follows: RPM, map, engine temp, air temp, battery, fuel pressure, oil pressure, tps, point, inj duty A and inj duty B.

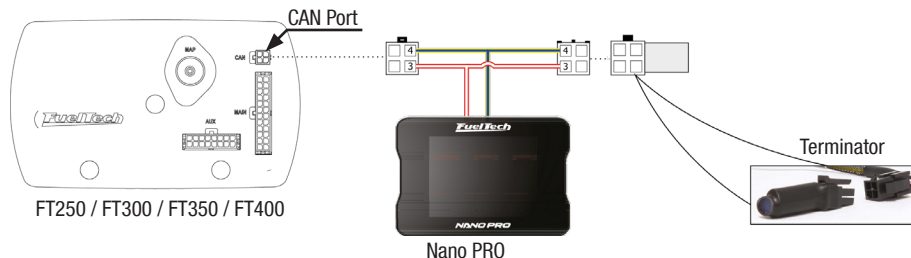

IMPORTANT

When using the Nano PRO with an FT250 or FT300 you need to disable the Datalog function.

8. Configuration through the Nano PRO interface

It is possible to configure the FuelTech Nano PRO entirely from the screen. Below are a few example screens.

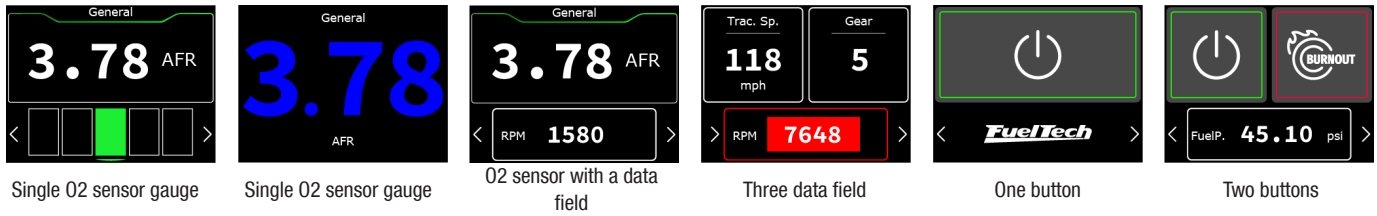

Wizard

The first connect Nano PRO or then perform a factory reset, a menu is displayed to choose the type of communication that the module will execute.

- Select the Nano PRO language.
- Choose the type of communication that Nano PRO will work.
 - **FTCAN 1.0 and 2.0:** for the module is connected via CAN Network to a ECU FuelTech.
 - **OBDII:** to use Nano PRO as an OBDII reader for stock cars.
 - **None:** mode that disables CAN communication, Nano PRO works only as a conditioner O2 sensor.
- This configuration is used to choose the type of O2-sensor that the Nano PRO works.

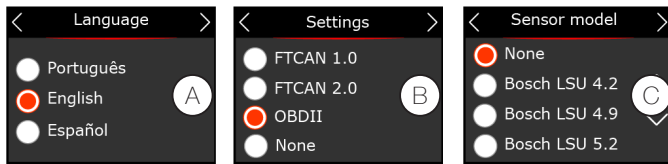

Using the interface

To navigate between screens, press the buttons (1) in the lower corners of the interface.

There are two ways to get into the menu:

- Press button (1) to change screens until you reach the menu screen.
- Press and hold the button (1) for one second to go directly to the menu.

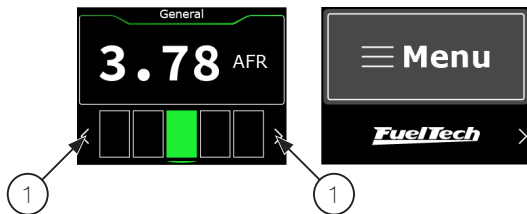

8.1 Dashboard configuration

Configures the number and information of the dashboards. It is possible to create up to 5 different dashes.

Configure here the screen that will be the main dash, presented on startup of the Nano PRO. You can choose the total number of Dashboards, for that, click on one of the 3 free spaces.



Wideband meter

There are two possibilities for viewing the O2 sensor value.

Ideal range bar: In this option, the O2 sensor value will be shown on the display and just below a bar with the ideal range of air/fuel mixture.

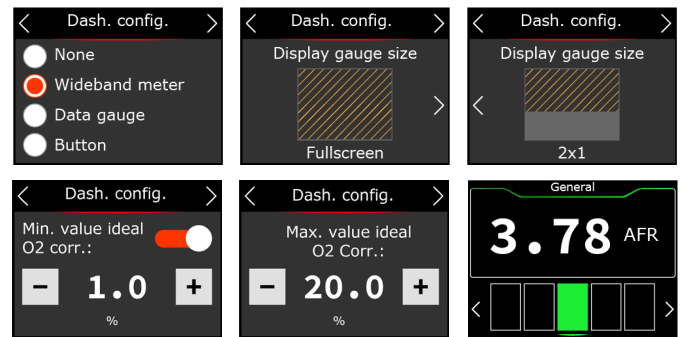

Gauge function for closed loop

The range is divided into 5 parts being numbered from left to right from 1 to 5 and is adjusted according to the limits set in the closed loop function.

- 1st: (red) value equal to the lower correction limit defined in the ECU map.
- 2nd: (yellow) value less than the lower limit set in the ECU up to the ideal minimum value O2 corr. set in the Nano PRO.
- 3rd: (green) value between the limits configured in the images above.
- 4th: (yellow) value upper than the ideal maximum value set in the Nano PRO up to the upper limit of the correction in the ECU map.
- 5th: (red) Value equal to the upper limit of the correction defined in the ECU map.



NOTE

To display a bigger O2 value on the display, do not configure the ideal range values.

Value only: in this option the O2 sensor value will be very similar to the WB-O2 Nano. Only the O2 sensor value will be displayed. In this case, it is possible to configure the color of the value shown on the display.

Available colors: white, blue, green, yellow, red and orange.

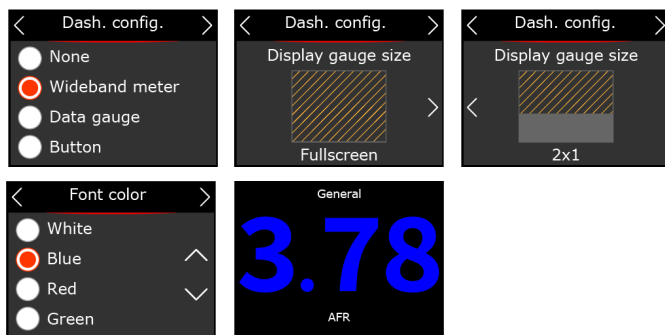

Select which will be the Nano PRO's main dash screen. It's possible to configure any of five screens as the main screen.

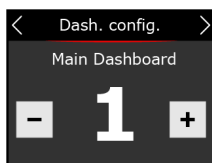

Data gauge

Select which data will be displayed in each dash. It is possible to configure up to 3 parts of information per screen with different sizes and positions.

If necessary, also configure the minimum and maximum values for each configured information. These alerts are displayed on the Nano PRO screen and are independent of the ECU, and may be different values from those configured in each module.

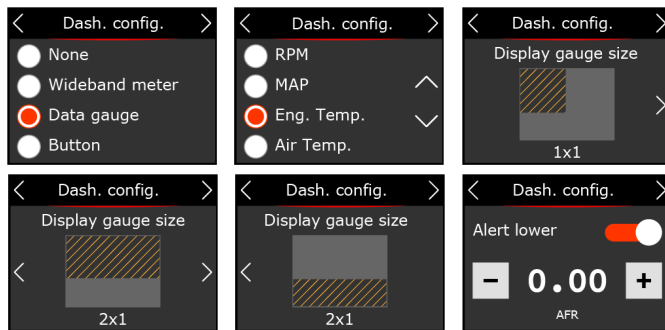

Button

Select which buttons will be triggered in each dash. It is possible to configure up to 2 buttons per screen.

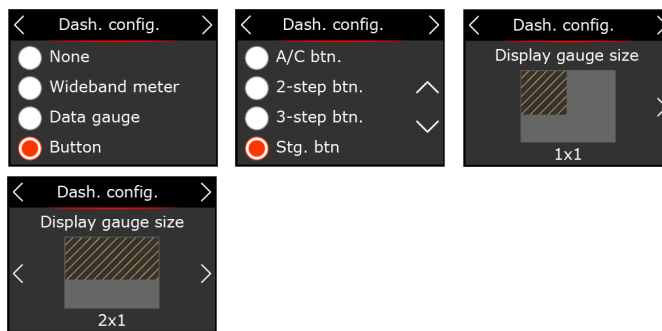

After each configuration it is necessary to go to the last screen and click on the save button.



IMPORTANT

Buttons to work correctly, it is necessary to configure the inputs in the ECU map in the FTManager software.



NOTE

When the screen remains idling with no input from the user for longer than 10 seconds, the action is canceled and the interface returns to the main screen.

8.2 Display configuration

In this menu you can choose the screen lighting in day and night modes. These values are independent of the ECU, that is, the day and night values can be different between ECU and Nano PRO Switching between modes can be activated by a button on the Nano PRO screen or come directly from the ECU via the FTCAN 2.0 network.

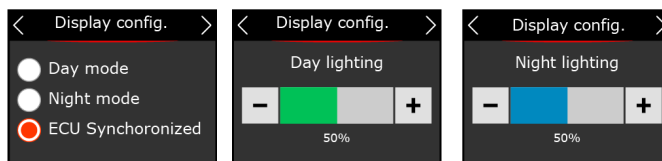

After lighting setup, the display calibration screen will appear. It is recommended that it be done on the first installation and whenever you notice difficulty in touching the screen.



8.3 Heating setup

O2 sensor heating is essential for starting the lambda sensor reading. On the Nano PRO there are 3 heating modes:

Normal: Standard heating currently used by the WB-O2 Nano. This is the recommended mode for FuelTech ensuring a longer O2 sensor life.

It is possible to choose one of the three parameters to start the heating in automatic mode (whenever it is turned on), by temperature or RPM.

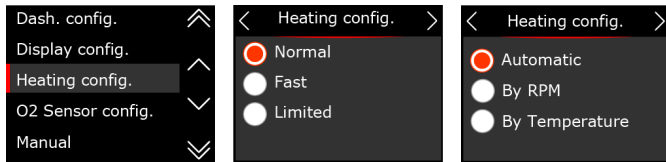

Fast heating, uses a high current to shorten the heating time. By using this option the O2 sensor life will be drastically reduced.

It is possible to choose one of the three parameters to start the heating in automatic mode (whenever it is turned on), by temperature or RPM.

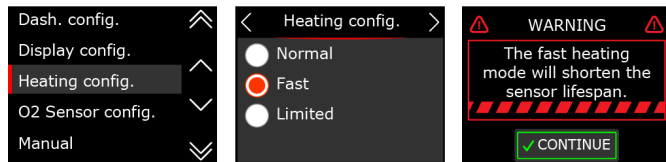

Limited: Limits heating current to 2, 2.5, and 3 Amps

It is possible to choose one of the three parameters to start the heating in automatic mode (whenever it is turned on), by temperature or RPM.

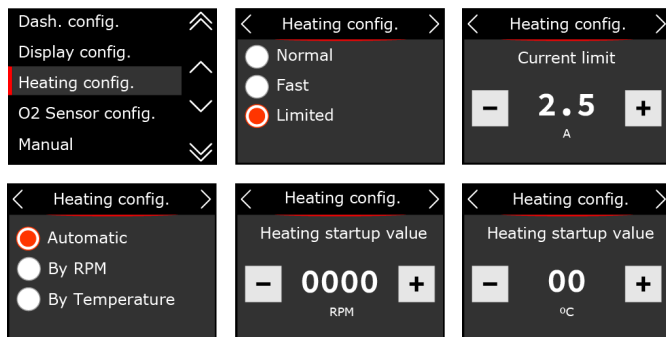

8.4 O2 sensor configuration

Select the model of the O2 sensor installed in the car. On the next screen configure the installation position.

The next step is to define the unit, fuel type and also the working scale (analog output).

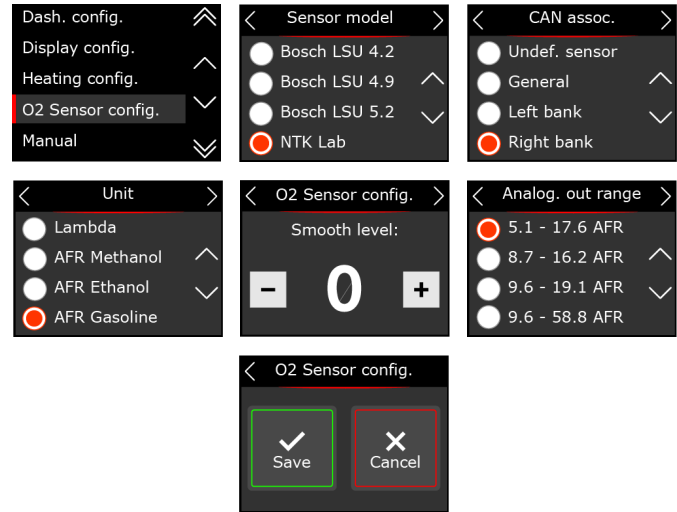

Procedure for replacing the lambda O2-sensor

Perform the procedures described below to change the probe:

- a - Disconnect the old O2 sensor and remove it.
- b - Change the configuration for the new O2 sensor on the Nano PRO.
- c - Turn off the module.
- d - Connect the new O2 sensor.
- e - Turn on the Nano PRO.

Free-air calibration - NTK sensor

The NTK O2 sensor needs an open air calibration, so after configuring in the software it is necessary to connect the sensor to the Nano PRO and carry out the calibration.

To perform this procedure, first connect the O2 sensor to the Nano PRO and leave it out of the exhaust. Turn the ignition on, and let the NTK O2 sensor heat up for 5 minutes, then access the sensor setup menu, select NTK, and click on the "calibrate" button.

The calibration process is executed 5 times to guarantee the expected result, after the test a message with the result will appear on the screen. If an error message is displayed, it is necessary to repeat the calibration procedure.

Possible errors after calibration - NTK sensor

- Current highest 4.3 -> faulty sensor
- Current below 3.2 -> sensor is not Free-air

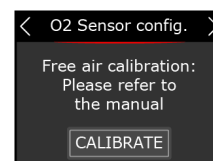

Hour-meter - NTK sensor

This function allows checking the usage time of the probe installed in the equipment. There is a RESET button to reset the usage time count.



8.5 Manual

Through the interface there is a QR Code to download the manual in its complete version with all the necessary information for the operation of the Nano PRO.



8.6 Language

Fueltech Nano PRO has the possibility of changing language for the interface.

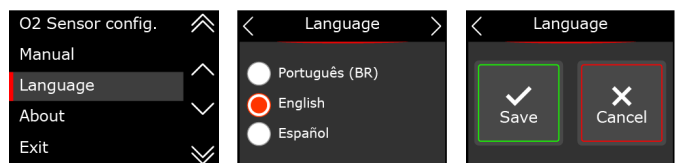

8.7 About

This menu shows the O2 sensor usage time and the average heating time, as well as the hardware, software and serial number of the Nano PRO. It is also possible to reset the O2 sensor usage time by clicking on the "Reset" button.

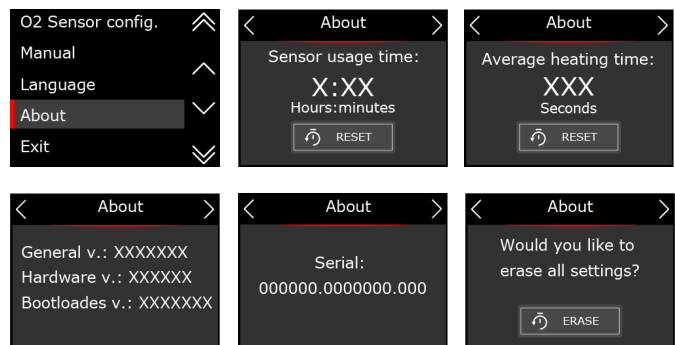

87.8 Settings

In this menu, the CAN communication mode is configured.

FTCAN 1.0: For old line ECUs (FT250, FT300, FT350 and FT400) this configuration allows you to receive information from the following ECU channels: RPM, map, engine temp, air temp, battery, fuel pressure, oil pressure, tps, time , inj duty A and inj duty B.

To display this information, it is necessary to configure the gauges in section "7.1 Panel configuration" on page 13.

It is also possible to configure a shift alert for FuelTech Nano PRO, this alert is independent of the ECU.

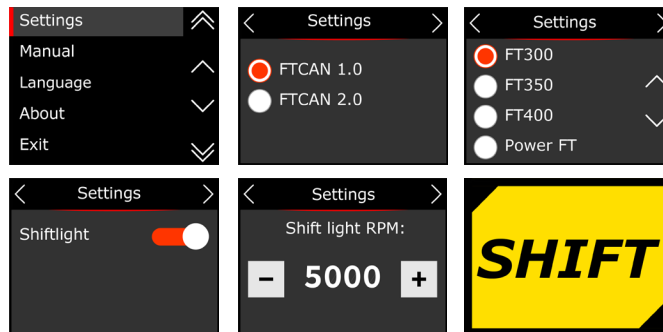

IMPORTANT
When using the Nano PRO with an FT250 or FT300 the datalog function is automatically disabled.

To disable the internal Datalogger follow the steps in the image below.

- 1 - Click the down button until you locate the internal Datalogger menu.
- 2 - Click the button to the right.
- 3 - Click the down button until the "Internal Log disabled" information appears.

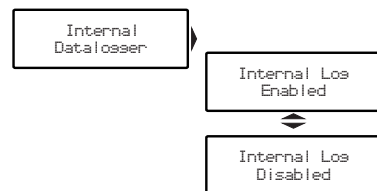

FTCAN 2.0: This protocol allows communicating with the PowerFT line modules (FT450, FT500, FT550 and FT600), with this configuration it is possible to configure buttons to ECU functions on/off, read EGT sensors, the RPM shift light and Alerts synchronized with the ECU.

ECU Alerts: These warnings are activated when the condition configured in the ECU is reached, and will remain active until the user touches the screen. They will reappear after 10 seconds if the condition configured in the ECU still persists.

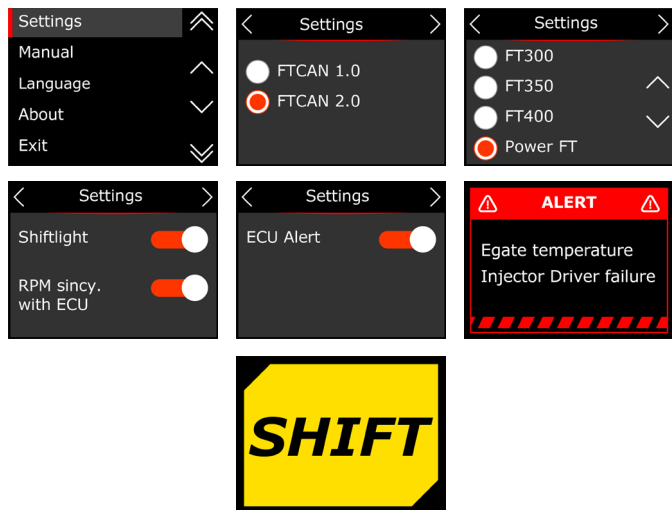

OBD-II: This protocol allows to read the parameters of original cars through the OBD-II connector with CAN protocol. For the correct display of the parameters in the Nano PRO it is necessary to configure the measurement units such as temperature, pressure, speed, and consumption.

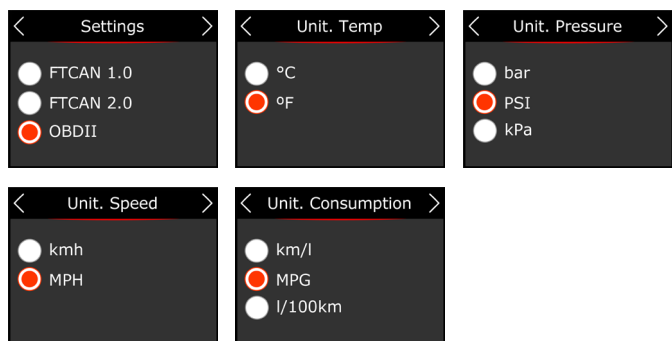

After this configuration is necessary to configure the screens with the parameters to be displayed, for this see the item "8.1 Panel Configuration".

List of Nano PRO OBD-II compatible cars

Below is a list of cars already tested and that are compatible with CAN reading through OBD-II.

Brand	Car	Year
BMW	530i	2021
	328i	2015
	535i F10	-
	335i F30	2012
	330i	2023
VW	Fox	2013
	Saveiro	2016
	Virtus	2023
	Jetta	2008
	Tiguan	2021

VW	Fox	2015
	Amarok	2014
	EOS TSI	2010
	Polo TDI	-
	Golf GTI	2015
Chevrolet	Prisma	2019
	Camaro	2010
	Opel Corsa D	
Renault	Spin	2021
	Symbol	-
Jeep	Duster	2011
	Compass (diesel)	2018
FORD	Ka	2013 a 2016
	Focus	2009
	Fiesta 1.6	2012 a 2014
	Fiesta ST	2015
	F150 Shelby	2018
Peugeot	F150 5.0	2014 a 2016
	208 GT THP	2017
Toyota	Partner	-
	Etiós	2017
Mitsubishi	Corolla GR	2022
	ASX	2013
Troller	EVO X	2011 a 2014
	Troller	2021
Subaru	STI	2017
	Civic SI	2008 a 2011
Honda	FIT	2015
	Sprinter	2012
Mercedes	Uno Way	2015
	Argo	-
Nissan	GTR	2009
	Seat	Ibiza TSI
Porsche	Cayenne	2020
	Citroen	C4 Cactus
Audi	RS3	2019
	Land Rover	Discovery
Dodge	RAM rampage	-
	Mini cooper	Clubman

Nano PRO is only compatible with ISO15765-CAN protocol, some vehicles use another protocol and with that the Nano PRO will not work. Consult technical support to find out what the standard protocol of your vehicle is.

List of cars INCOMPATIBLE with Nano PRO OBD-II

Below is a list of already tested cars that are NOT compatible with Nano PRO.

Brand	Car	Year
Fiat	Siena	2011
	Doblo	2013
	Palio	2008
	Uno	2009
	Punto T-Jet	2016
Chevrolet	Blazer	2006
	Celta	2011
	Silverado (diesel)	2017
	Onix	2018 a 2021
	Opel Corsa C	-
	Envoy V8	-
Honda	Fit	2008
	City	2010
Peugeot	207	-
Mercedes	E55	2003
	S214	
BMW	540i	2001
Mitsubishi	Airtrek	2009

- Ethanol %
- Fuel differential pressure absolute
- Injection time
- Fuel flow
- Gear
- Lambda
- Sensor O2 Narrow band Voltage

There will be cases where the channel will be available in Nano PRO but the vehicle does not have this information in the CAN, in this case the gauge will be with (----) and may be replaced by other information that it deems relevant.

Information available on OBD-II for reading

The channels that are available for reading through OBD-II are:

- Load engine
- Engine Temperature
- Fuel short term correction
- Fuel long term Correction
- Fuel pressure
- MAP
- RPM
- Speed
- Advance of Ignition
- Air Temperature
- TPS
- Oil temperature
- Fuel differential pressure
- Fuel differential pressure gauge
- O2 Sensor Bank 1 Sensor 1
- O2 Sensor Bank 1 Sensor 2
- O2 Sensor Bank 2 Sensor 1
- O2 Sensor Bank 2 Sensor 2
- Barometric pressure

9. Configuration via the FTManager interface

To configure the Nano PRO through the FTManager software, follow the steps described below:

- a - Open the map in FTManager software
- b - Access the “Tools” menu and then click on “External Modules” and locate Nano PRO and open the configuration screen.

This screen is divided into four distinct parts.

- 1 - Dashboard configuration: Allows you to configure the 5 dashboard screens with the data you deem necessary, as well as define which will be the main screen.
- 2 - Advanced Settings: There are three tabs with all the necessary settings for the Nano PRO to operate correctly
 - **Display and language:** select the language of the Nano PRO and set the brightness levels for day and night mode.
 - **Heating:** adjusts the O2 sensor heating mode and sets the parameters of RPM and minimum temperature for the start of heating.
 - **O2 sensor:** defines which sensor will be used, Unit of measure and the Range of the analog output.
 - **CAN Network:** configures the network protocol used, FT CAN 1.0 or 2.0, as well as triggering alerts and shift light.
 - **Units:** Configures the units for temperature, pressure, speed, consumption and flow.
- 3 - Buttons and Nano PRO selection: there are four buttons for reading and writing the settings in the Nano PRO memory as well as selecting which device is being configured (if you have more than one Nano PRO on the CAN network).
- 4 - Serial number and hardware and firmware version.

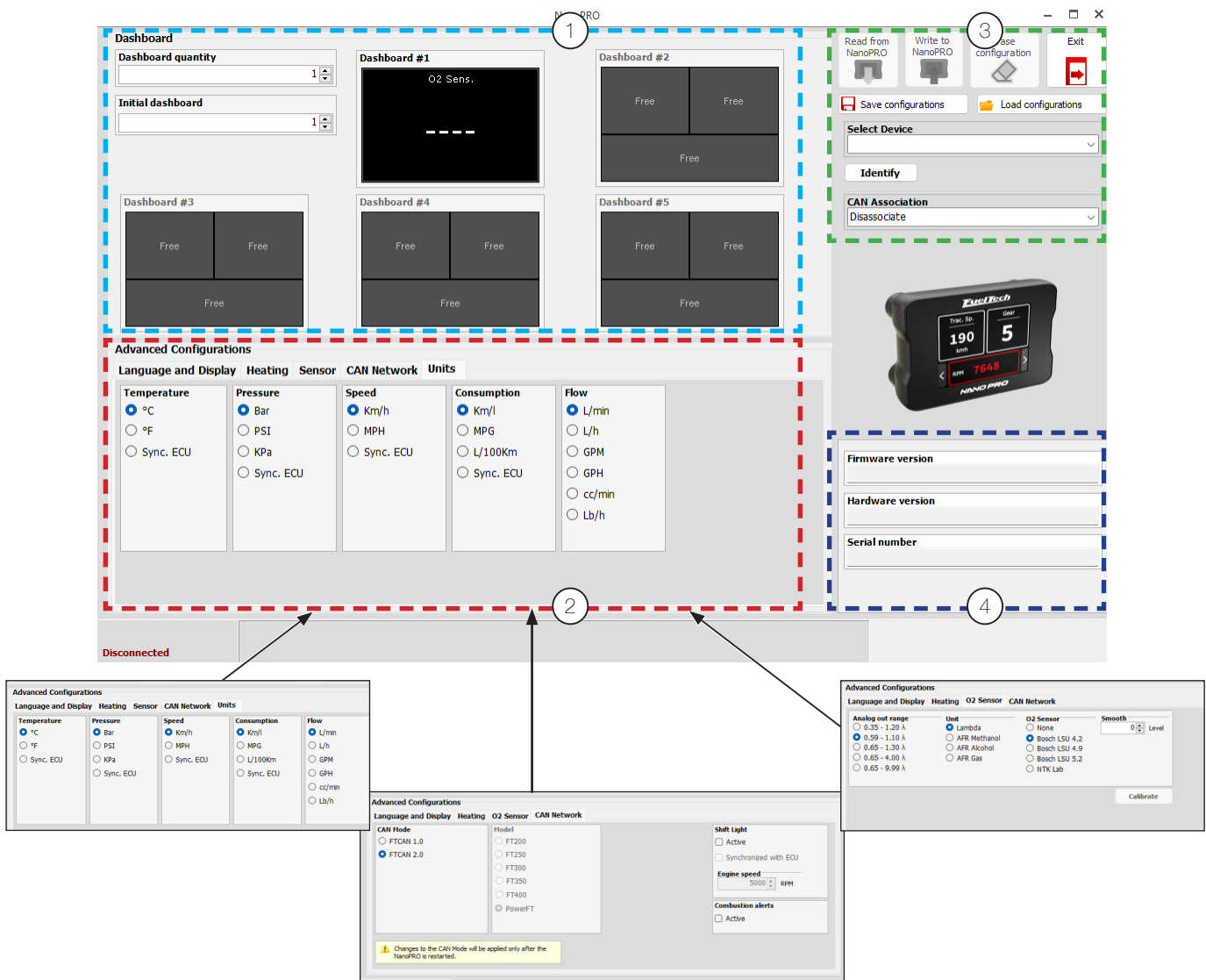

Configuration to use Nano PRO out of the CAN network

Nano PRO allows the selection of the display unit and O2 sensor reading scale, but, these settings are read from the PowerFT ECU's during its initialization. In case it is removed from the CAN network, Nano PRO goes back to factory configuration.

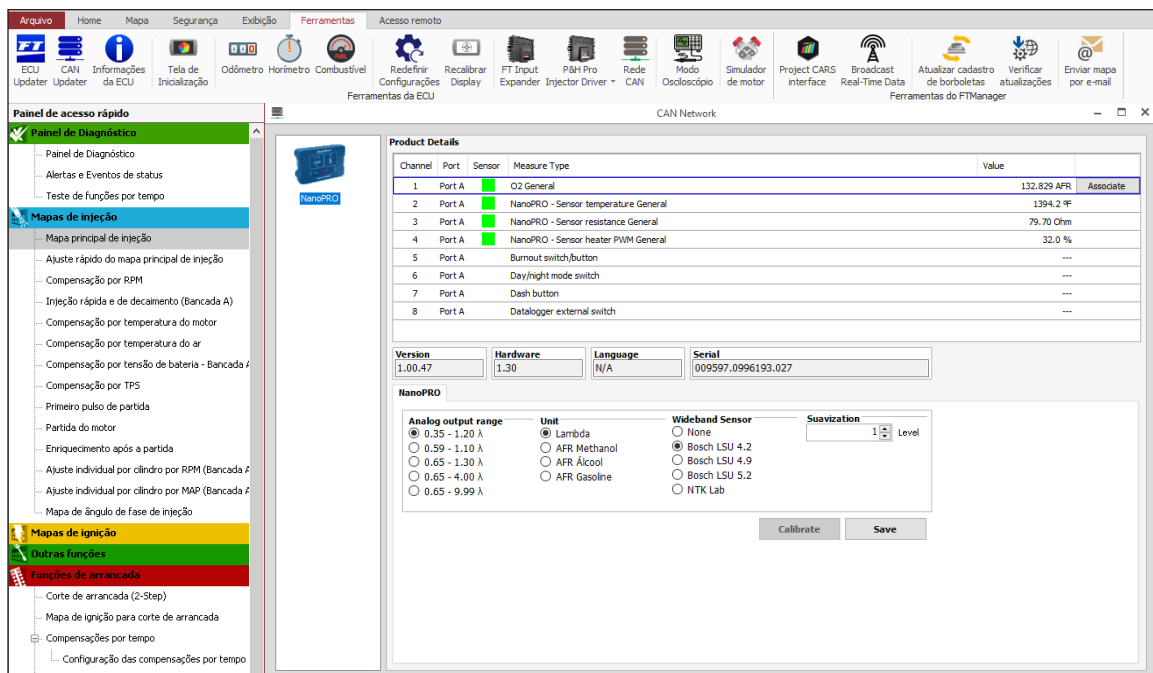

9.1 Datalogger channels

There are 3 log channels for each O2 sensor fitted to the vehicle, which record information about the O2 sensor heating. With these channels it is possible to have a complete diagnosis, letting you know if the sensor is installed in the correct position, for example.

Sensor heater PWM: Records the percentage of duty cycle applied to the O2 sensor heater

Sensor temperature: Records the internal temperature of the sensor

Sensor resistance: Records the internal resistance in Ohms of the sensor

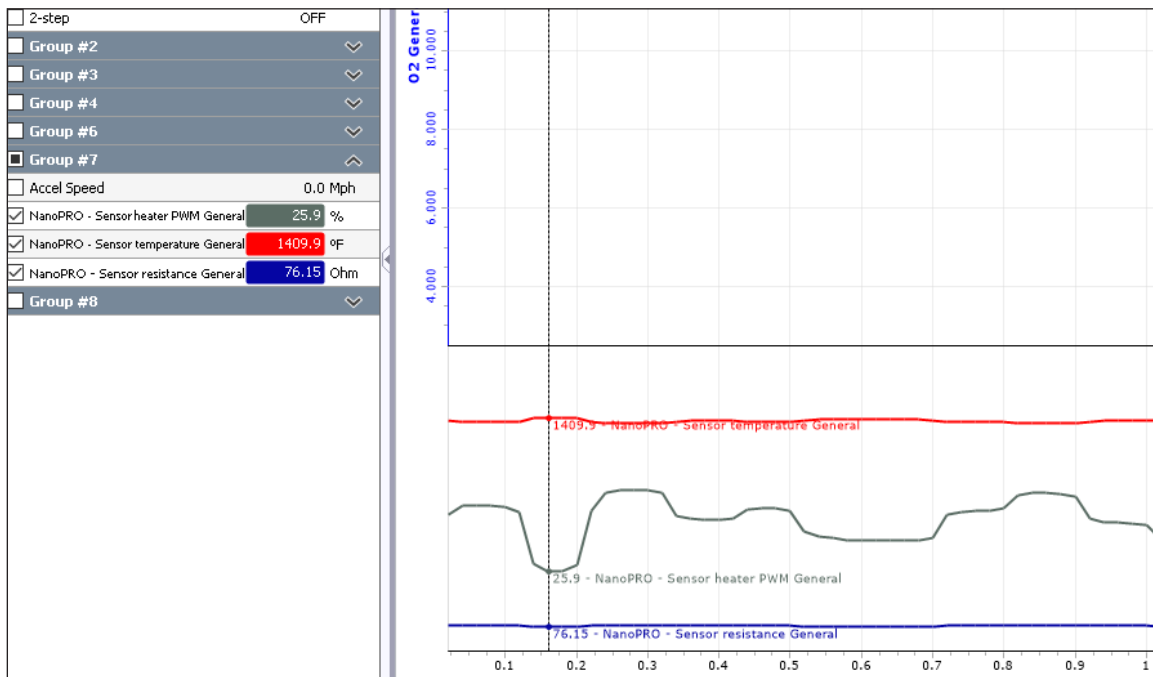

9.2 Nano PRO software update

To update the Nano PRO software, follow the steps described below:

- a - Connect the ECU through the USB cable to the computer and open the FTManager software.
- b - Turn ON the ignition key.
- c - In the FTManager software, on the “Home” tab, click on the button “Read ECU” (1) to open the map in the software.

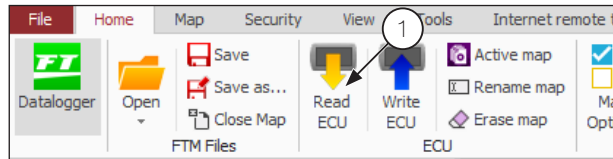

- d - Open the “Tools” tab and click on the button “CAN Updater” (2);

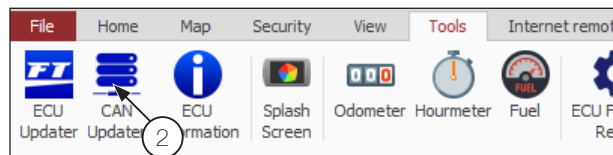

- e - A screen for updating the Nano PRO Software will open. On the left (3) of the screen will appear all the equipment available on the CAN network. Select which Nano PRO will be updated.
- f - Click on the button “Update” (4).
- g - Wait for the update process to finish, after that the Nano PRO will restart automatically.
- h - Check the Nano PRO settings. See “9. Configuration via the FTManager Interface” on page 16, or directly from the Nano PRO interface.

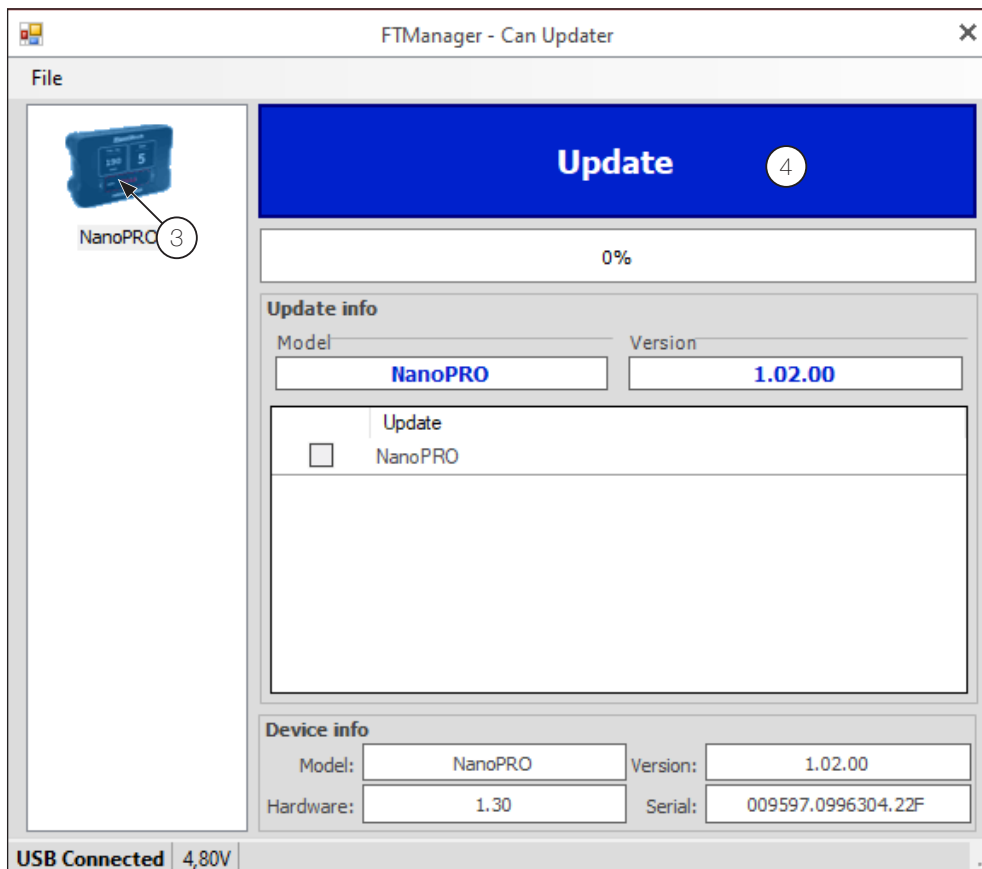

10. Lambda readings analog outputs

10.1 Lambda analog output in Volts – 5.14 to 17.6 AFR

Lambda	AFR Gasoline	AFR Methanol/Ethanol	Volts (V)
0,35	5,14	2,3	0,20
1,20	17,6	7,7	4,80

10.2 Lambda analog output in Volts – 8.7 to 16.2 AFR (default)

Lambda	AFR Gasoline	AFR Methanol/Ethanol	Volts (V)
0,59	8,7	3,8	0,20
1,10	16,2	7,1	4,80

10.3 Lambda analog output in Volts – 9.6 to 19.1 AFR

Lambda	AFR Gasoline	AFR Methanol/Ethanol	Volts (V)
0,65	9,6	4,2	0,20
1,30	19,1	8,3	4,80

10.4 Lambda analog output in Volts – 9.6 to 58.8 AFR

Lambda	AFR Gasoline	AFR Methanol/Ethanol	Volts (V)
0,65	9,6	4,2	0,20
4,00	58,8	25,7	4,80

10.5 Lambda analog output in Volts – 9.6 to 146.9 AFR

Lambda	AFR Gasoline	AFR Methanol/Ethanol	Volts (V)
0,65	9,6	4,2	0,20
9,99	149,9	64,1	4,80

When there is an output reading error, the analog output locks at 0.00V. Thus, it is possible to know if there is any problem or error in the equipment. To configure this output on external equipment, it is necessary to supply the first and last values of the table above.

11. Analog output lambda/AFR

AFR (Gasoline)	AFR (Methanol)	Lambda
4.120	1.800	0,280
6.470	2.820	0,440
7.640	3.340	0,520
8.530	3.720	0,580
9.260	4.040	0,630
10.000	4.370	0,680
10.580	4.620	0,720
11.170	4.880	0,760
11.760	5.140	0,800
12.500	5.460	0,850
13.380	5.840	0,910
14.700	6.420	1,000
16.320	7.130	1,110
18.380	8.030	1,250
21.020	9.180	1,430

AFR (Gasoline)	AFR (Methanol)	Lambda
24.400	10.660	1,660
26.460	11.560	1,800
28.960	12.650	1,970
32.050	14.000	2,180
35.720	15.600	2,430
40.430	17.660	2,750
46.310	20.220	3,150
53.950	23.560	3,670
59.240	25.870	4,030
65.420	28.570	4,450
72.770	31.780	4,950
82.320	35.950	5,600
110.250	48.150	7,500
167.870	73.320	11,420
343.250	149.910	23,350
470.400	205.440	32,000

12. Nano PRO codes

12.1 Informative codes

When turning Nano PRO power on, the following information will be displayed:

Product name

Then the word HEATING indicates the O2 sensor heating for operation.

After heated, the word HI appears when AFR above 146.9 AFR Gas (64.1 AFR Alcohol) is read.

12.2 Error codes

VCC = 12V Power / GND = Ground

Cod Error	Description	Procedure
E01	Internal processor error	- It is necessary to send the equipment to FuelTech technical assistance
E02	Sensor disconnected or damaged	- Check the wiring harness. - Check connection between harness and sensor plugs. - Replace the sensor.
E03	Heater Short circuit with the GND	- Check the wiring harness. - Check and improve ground or power. - Check the connection between the harness and sensor plugs. - Replace the sensor
E04	Short circuit with the VCC	- Check the wiring harness. - Check and improve ground or power. - Check the connection between the harness and sensor plugs. - Replace the sensor
E05	Signal Short circuit with the GND	- Check the wiring harness. - Check the connection between the harness and sensor plugs. - Check Spark Plugs, Spark Plug Cables. - Check where the harness passes through to look for possible damage. - Replace the sensor.
E06	Signal Short circuit with the VCC	- Check the wiring harness. - Check the connection between the harness and sensor plugs. - Check Spark Plugs, Spark Plug Cables. - Replace the sensor.
E07	Supply voltage below 10V (while starting)	- Check the module's positive and negative. There is a drop in the supply voltage
E08	If it stays fixed on the screen, it indicates a communication failure with the O2-sensor. If it just flashes when turning on, it indicates that there was a failure and it has normalized.	- Test another O2-sensor - Check the O2-sensor harness - If the problem persists, send the module to FuelTech technical assistance.
E09	Sensor not configured	- Configure an available sensor model see "8.4 O2 sensor configuration" on page 16
E10	Heating error	- Check that the sensor in use matches the one configured on the Nano PRO - Check the electrical harness, connectors - Replace the probe
E11	Heater circuit error	- It is necessary to send the equipment to FuelTech technical assistance

13. Fixing template (in)

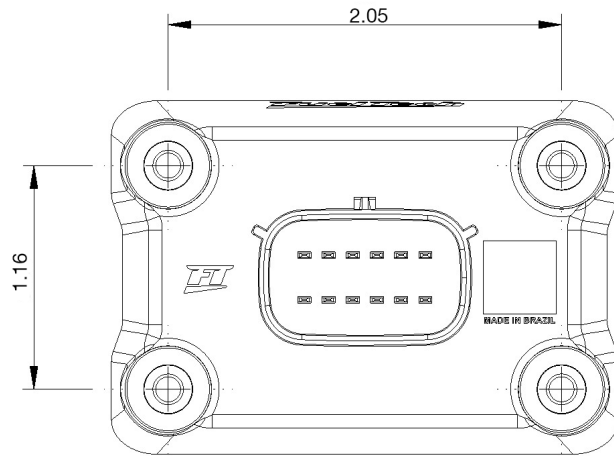

FuelTech

USA

455 Wilbanks Dr.
Ball Ground, GA, 30107, USA

Phone: +1 678-493-3835

E-mail: info@FuelTech.net
www.FuelTech.net

 **FuelTechUSA**

BRASIL

Av. das Indústrias, 864,
Anchieta Porto Alegre, RS,
Brasil CEP 90200-290

Fone: +55 (51) 3019 0500

E-mail: sac@FuelTech.com.br
www.FuelTech.com.br

 **FuelTechEMS**